

NOTE:
 AIR/MOISTURE BARRIER
 INSTALLER MUST PROVIDE
 WEATHER TIGHT SEAL AT
 ALL BARRIER TERMINATIONS

<p>THE INFORMATION CONTAINED IN THIS DRAWING IS THE SOLE PROPERTY OF METAL DESIGN SYSTEMS. ANY REPRODUCTION, IN PART OR WHOLE, WITHOUT THE WRITTEN PERMISSION OF METAL DESIGN SYSTEMS IS PROHIBITED.</p>	 METAL DESIGN SYSTEMS <small>DESIGNED FOR A PERFECT FIT.</small>	METAL DESIGN SYSTEMS 4150 C Street S.W. CEDAR RAPIDS, IA. 52404 Ph. (319) 362-7454		PROJECT SERIES 70 DETAILS		
		DRAWING DESCRIPTION STANDARD TERMINATION DETAIL				
		PROJECT NUMBER		DRAWING NUMBER S70-ACM-01A	DATE 6.02.14	
		MATERIAL		SCALE 6" = 1'-0"	DRAWN BY	

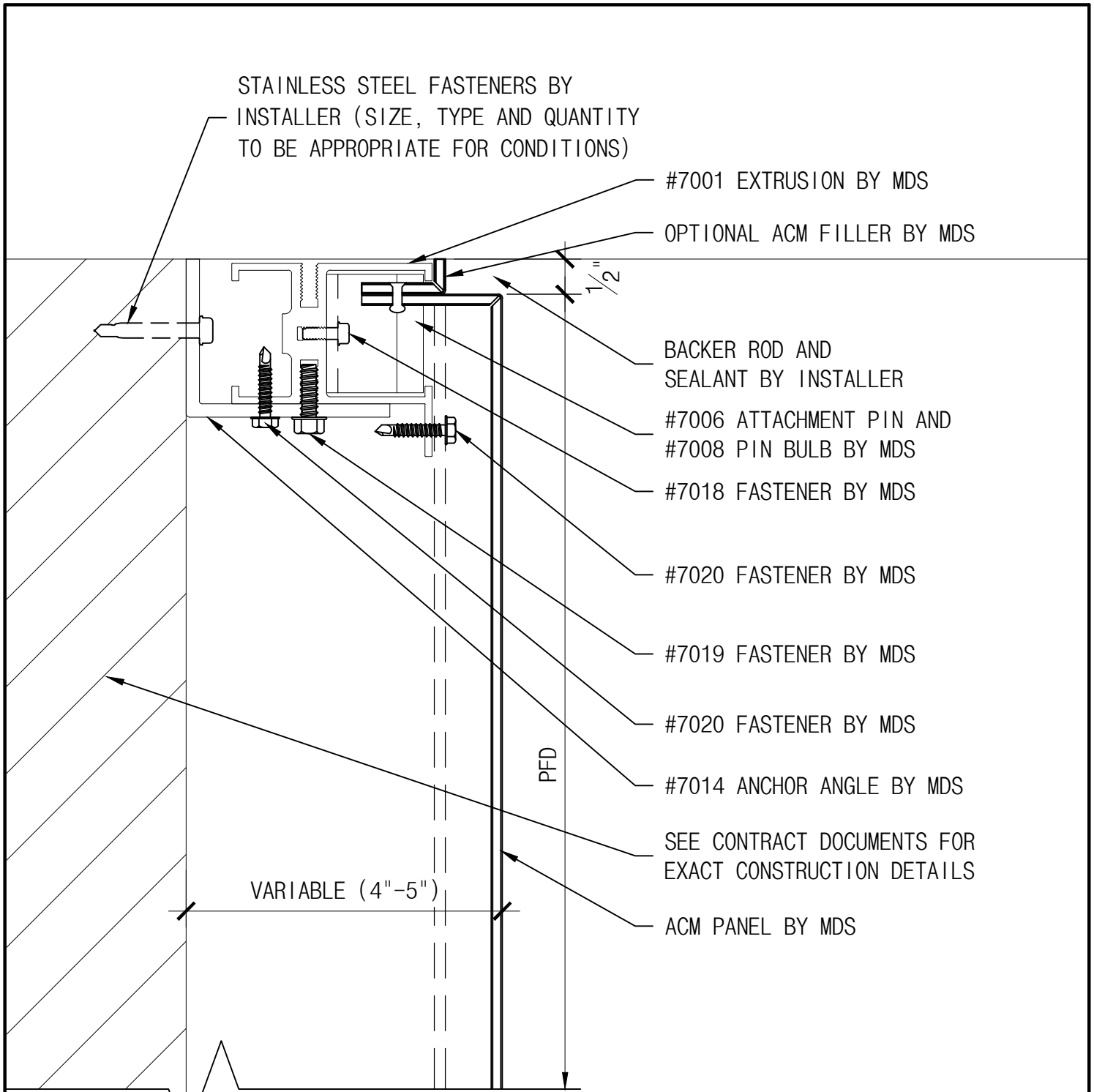

STAINLESS STEEL FASTENERS BY
INSTALLER (SIZE, TYPE AND QUANTITY
TO BE APPROPRIATE FOR CONDITIONS)

#7001 EXTRUSION BY MDS

OPTIONAL ACM FILLER BY MDS

BACKER ROD AND
SEALANT BY INSTALLER

#7006 ATTACHMENT PIN AND
#7008 PIN BULB BY MDS

#7018 FASTENER BY MDS

#7020 FASTENER BY MDS

#7019 FASTENER BY MDS

#7020 FASTENER BY MDS

#7014 ANCHOR ANGLE BY MDS

SEE CONTRACT DOCUMENTS FOR
EXACT CONSTRUCTION DETAILS

ACM PANEL BY MDS

VARIABLE (4"-5")

PFD

NOTE:
AIR/MOISTURE BARRIER
INSTALLER MUST PROVIDE
WEATHER TIGHT SEAL AT
ALL BARRIER TERMINATIONS

<p>THE INFORMATION CONTAINED IN THIS DRAWING IS THE SOLE PROPERTY OF METAL DESIGN SYSTEMS. ANY REPRODUCTION, IN PART OR WHOLE, WITHOUT THE WRITTEN PERMISSION OF METAL DESIGN SYSTEMS IS PROHIBITED.</p>	 METAL DESIGN SYSTEMS <small>DESIGNED FOR A PERFECT FIT.</small>	METAL DESIGN SYSTEMS 4150 C Street S.W. CEDAR RAPIDS, IA. 52404 Ph. (319) 362-7454	PROJECT SERIES 70 DETAILS			
		DRAWING DESCRIPTION ALT. STANDARD TERMINATION DETAIL				
		PROJECT NUMBER	DRAWING NUMBER S70-ACM-01B	DATE 6.02.14		
		SCALE 6" = 1'-0"		DRAWN BY		

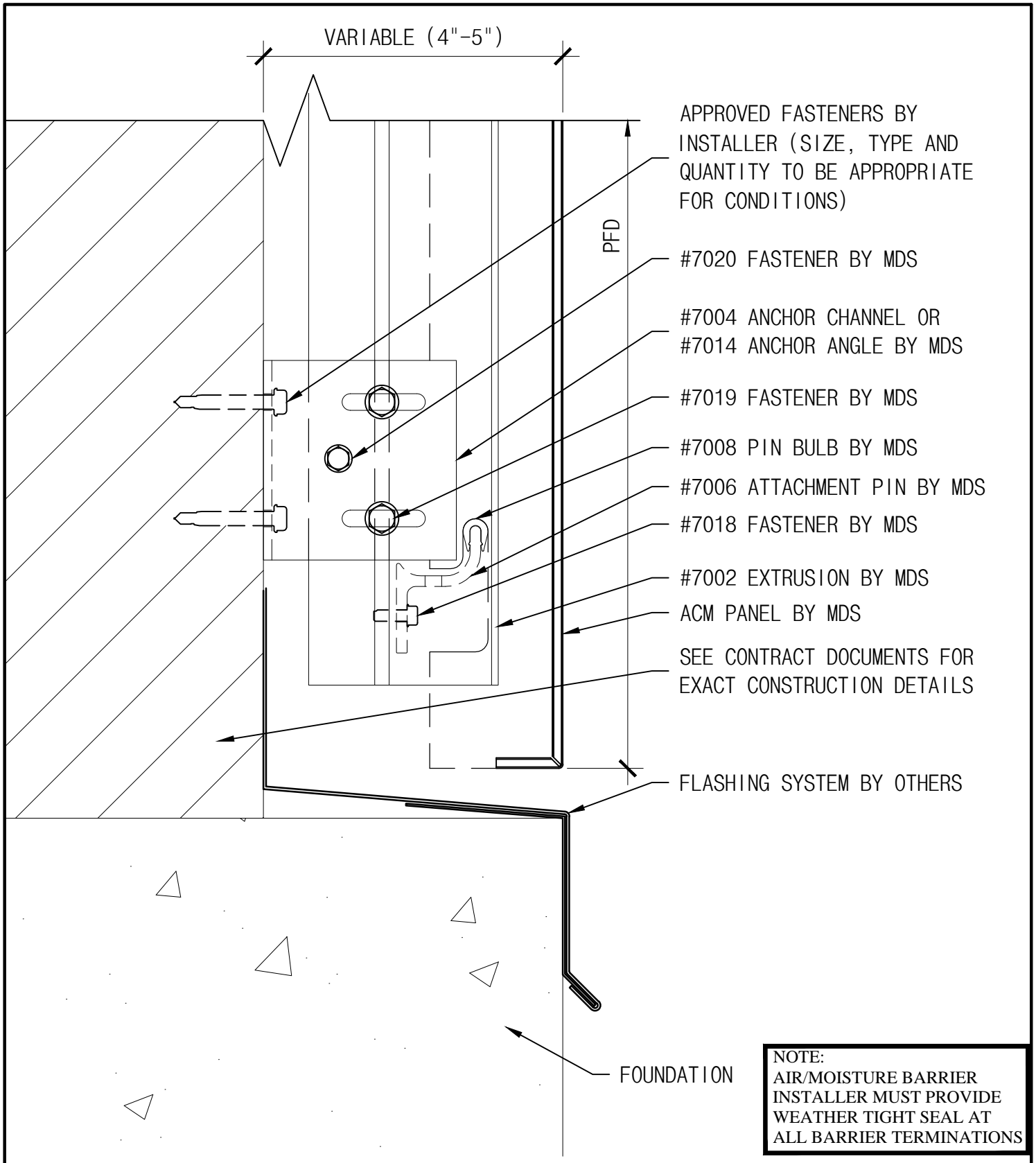

APPROVED FASTENERS BY
INSTALLER (SIZE, TYPE AND
QUANTITY TO BE APPROPRIATE
FOR CONDITIONS)

#7020 FASTENER BY MDS

#7004 ANCHOR CHANNEL OR
#7014 ANCHOR ANGLE BY MDS

#7019 FASTENER BY MDS

#7008 PIN BULB BY MDS

#7006 ATTACHMENT PIN BY MDS

#7018 FASTENER BY MDS

#7002 EXTRUSION BY MDS

ACM PANEL BY MDS

SEE CONTRACT DOCUMENTS FOR
EXACT CONSTRUCTION DETAILS

FLASHING SYSTEM BY OTHERS

FOUNDATION

NOTE:
AIR/MOISTURE BARRIER
INSTALLER MUST PROVIDE
WEATHER TIGHT SEAL AT
ALL BARRIER TERMINATIONS

<p>THE INFORMATION CONTAINED IN THIS DRAWING IS THE SOLE PROPERTY OF METAL DESIGN SYSTEMS. ANY REPRODUCTION, IN PART OR WHOLE, WITHOUT THE WRITTEN PERMISSION OF METAL DESIGN SYSTEMS IS PROHIBITED.</p>	 <p>METAL DESIGN SYSTEMS DESIGNED FOR A PERFECT FIT.</p>	<p>METAL DESIGN SYSTEMS</p>		<p>PROJECT SERIES 70 DETAILS</p>		
		<p>4150 C Street S.W. CEDAR RAPIDS, IA. 52404 Ph. (319) 362-7454</p>		<p>DRAWING DESCRIPTION TERMINATION AT FOUNDATION (TYP.)</p>		
		<p>MATERIAL</p>		<p>PROJECT NUMBER</p>	<p>DRAWING NUMBER S70-ACM-02A</p>	<p>DATE 6.02.14</p>
		<p>SCALE 6" = 1'-0"</p>		<p>DRAWN BY</p>		

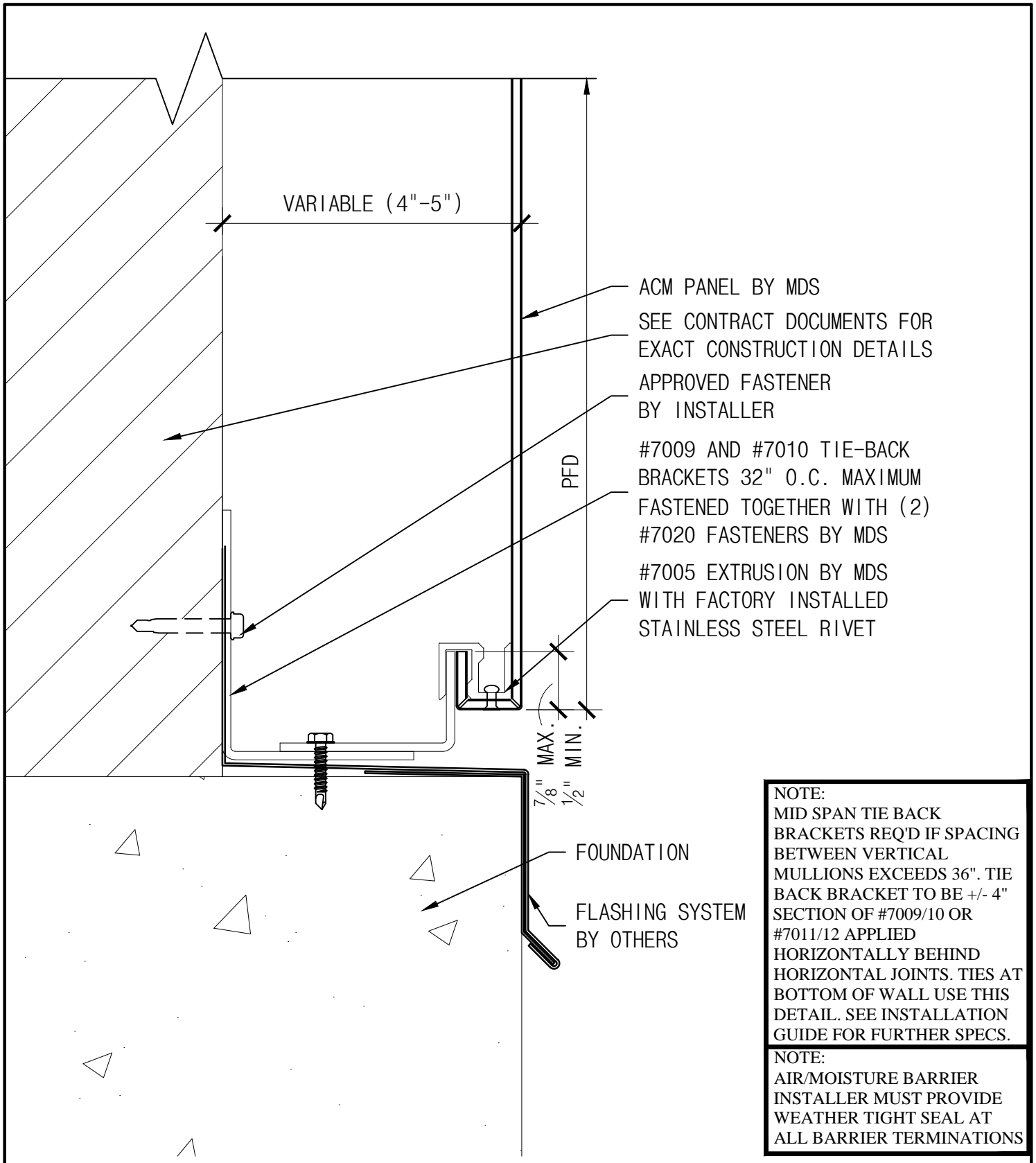

NOTE:
 MID SPAN TIE BACK BRACKETS REQ'D IF SPACING BETWEEN VERTICAL MULLIONS EXCEEDS 36". TIE BACK BRACKET TO BE +/- 4" SECTION OF #7009/10 OR #7011/12 APPLIED HORIZONTALLY BEHIND HORIZONTAL JOINTS. TIES AT BOTTOM OF WALL USE THIS DETAIL. SEE INSTALLATION GUIDE FOR FURTHER SPECS.

NOTE:
 AIR/MOISTURE BARRIER INSTALLER MUST PROVIDE WEATHER TIGHT SEAL AT ALL BARRIER TERMINATIONS

THE INFORMATION CONTAINED IN THIS DRAWING IS THE SOLE PROPERTY OF METAL DESIGN SYSTEMS. ANY REPRODUCTION, IN PART OR WHOLE, WITHOUT THE WRITTEN PERMISSION OF METAL DESIGN SYSTEMS IS PROHIBITED.

METAL DESIGN SYSTEMS
 4150 C Street S.W.
 CEDAR RAPIDS, IA. 52404
 Ph. (319) 362-7454

METAL DESIGN SYSTEMS
 DESIGNED FOR A PERFECT FIT.

PROJECT SERIES 70 DETAILS		
DRAWING DESCRIPTION FOUNDATION TERM. AT MID SPAN CLIP		
PROJECT NUMBER	DRAWING NUMBER S70-ACM-02B	DATE 6.02.14
MATERIAL	SCALE 6" = 1'-0"	DRAWN BY

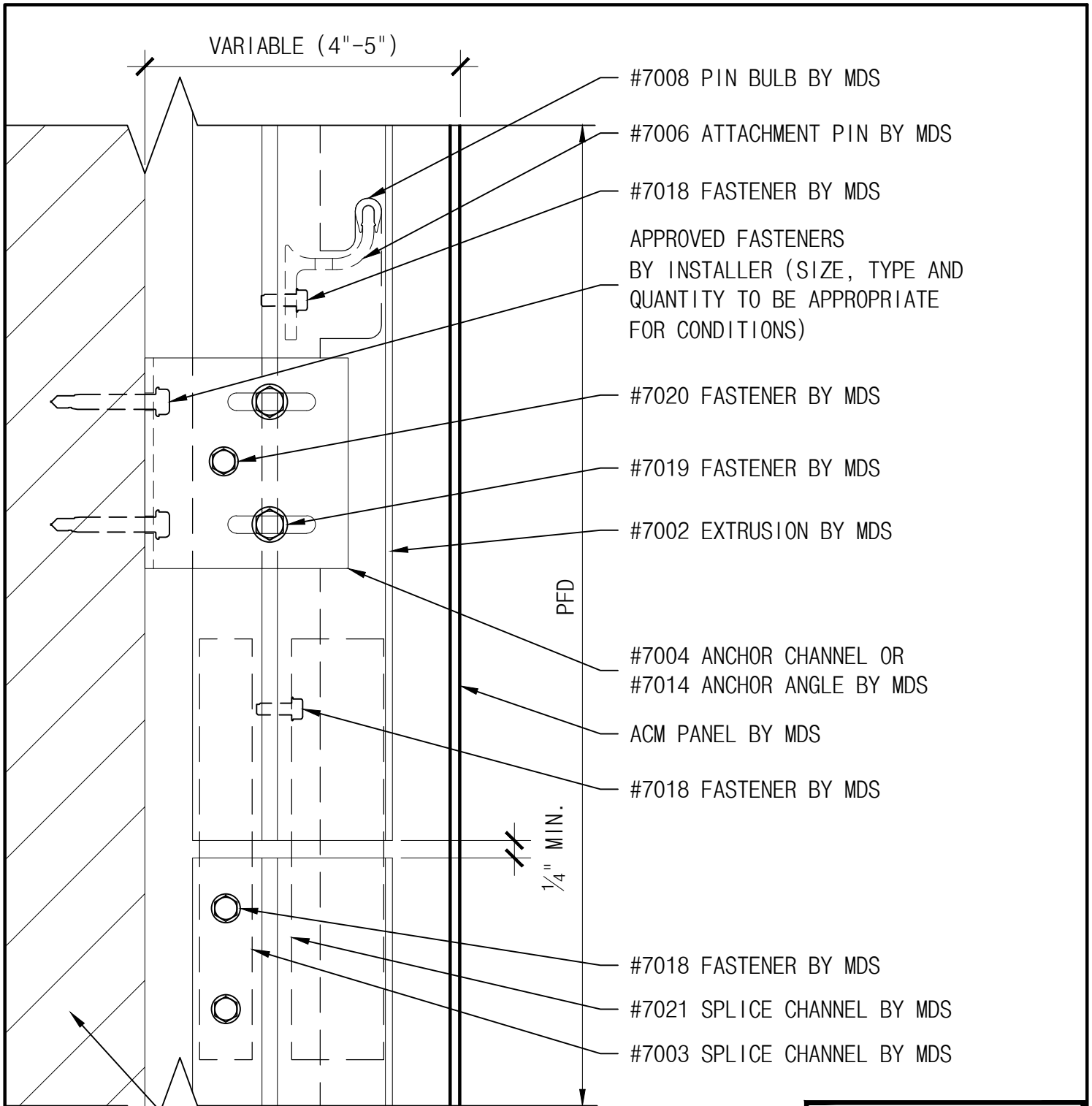

SEE CONTRACT DOCUMENTS FOR EXACT CONSTRUCTION DETAILS

NOTE:
 AIR/MOISTURE BARRIER
 INSTALLER MUST PROVIDE
 WEATHER TIGHT SEAL AT
 ALL BARRIER TERMINATIONS

<p>THE INFORMATION CONTAINED IN THIS DRAWING IS THE SOLE PROPERTY OF METAL DESIGN SYSTEMS. ANY REPRODUCTION, IN PART OR WHOLE, WITHOUT THE WRITTEN PERMISSION OF METAL DESIGN SYSTEMS IS PROHIBITED.</p>	 METAL DESIGN SYSTEMS <small>DESIGNED FOR A PERFECT FIT.</small>	METAL DESIGN SYSTEMS		PROJECT SERIES 70 DETAILS			
		4150 C Street S.W. CEDAR RAPIDS, IA. 52404 Ph. (319) 362-7454		DRAWING DESCRIPTION MULLION SPLICE DETAIL			
		MATERIAL		PROJECT NUMBER	DRAWING NUMBER S70-ACM-03	DATE 6.02.14	
		SCALE 6" = 1'-0"		DRAWN BY			

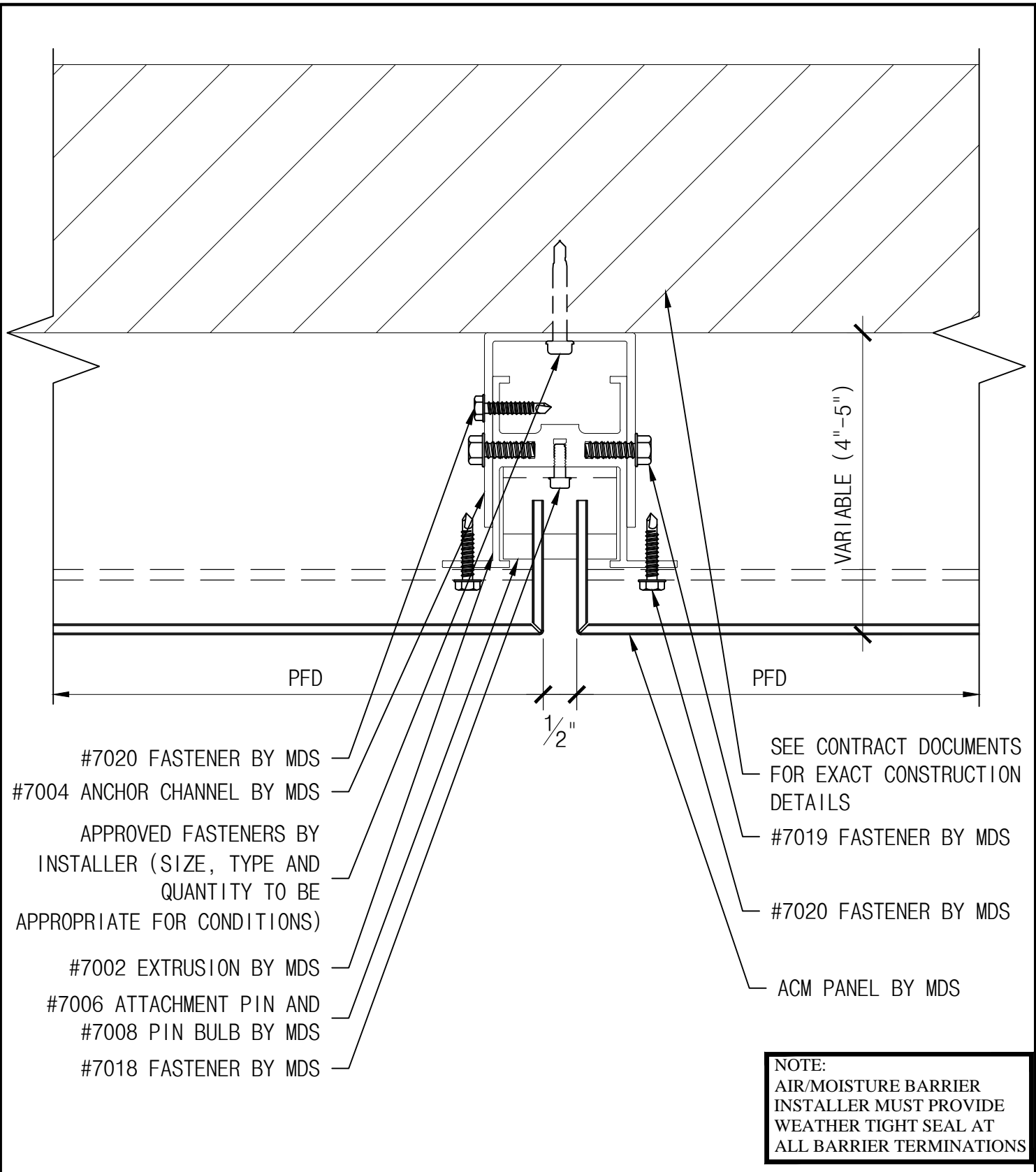

THE INFORMATION CONTAINED IN THIS DRAWING IS THE SOLE PROPERTY OF METAL DESIGN SYSTEMS. ANY REPRODUCTION, IN PART OR WHOLE, WITHOUT THE WRITTEN PERMISSION OF METAL DESIGN SYSTEMS IS PROHIBITED.



METAL DESIGN SYSTEMS
 4150 C Street S.W.
 CEDAR RAPIDS, IA. 52404
 Ph. (319) 362-7454

PROJECT SERIES 70 DETAILS		
DRAWING DESCRIPTION VERTICAL JOINT DETAIL (TYP.)		
PROJECT NUMBER	DRAWING NUMBER S70-ACM-04A	DATE 6.02.14
MATERIAL	SCALE 6" = 1'-0"	DRAWN BY

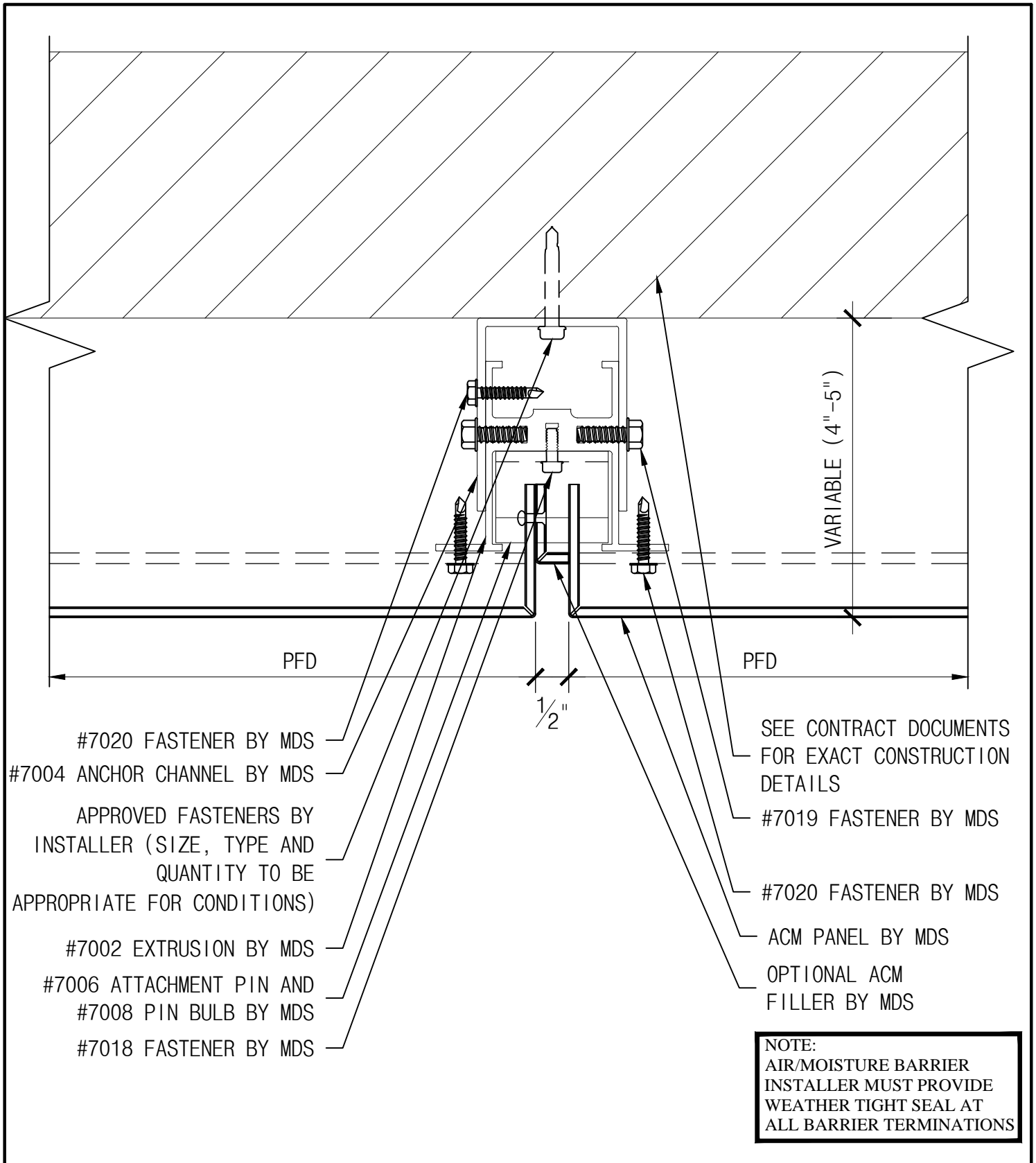

NOTE:
 AIR/MOISTURE BARRIER
 INSTALLER MUST PROVIDE
 WEATHER TIGHT SEAL AT
 ALL BARRIER TERMINATIONS

<p>THE INFORMATION CONTAINED IN THIS DRAWING IS THE SOLE PROPERTY OF METAL DESIGN SYSTEMS. ANY REPRODUCTION, IN PART OR WHOLE, WITHOUT THE WRITTEN PERMISSION OF METAL DESIGN SYSTEMS IS PROHIBITED.</p>	 METAL DESIGN SYSTEMS <small>DESIGNED FOR A PERFECT FIT.</small>	METAL DESIGN SYSTEMS		PROJECT SERIES 70 DETAILS			
		4150 C Street S.W. CEDAR RAPIDS, IA. 52404 Ph. (319) 362-7454		DRAWING DESCRIPTION VERTICAL JOINT DETAIL (TYP.)			
		MATERIAL		PROJECT NUMBER	DRAWING NUMBER S70-ACM-04B	DATE 6.02.14	
		SCALE 6" = 1'-0"		DRAWN BY			

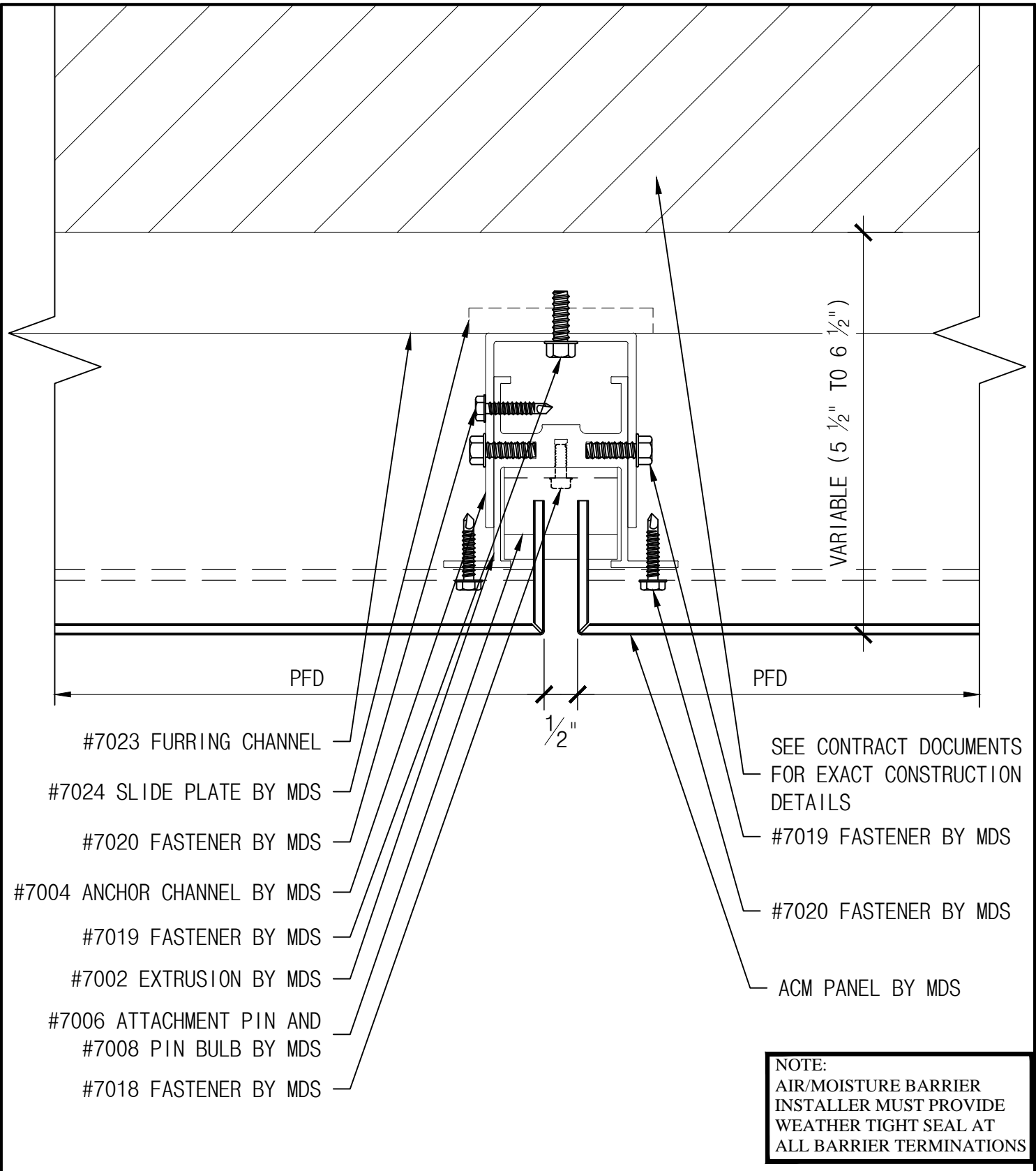

- #7023 FURRING CHANNEL
- #7024 SLIDE PLATE BY MDS
- #7020 FASTENER BY MDS
- #7004 ANCHOR CHANNEL BY MDS
- #7019 FASTENER BY MDS
- #7002 EXTRUSION BY MDS
- #7006 ATTACHMENT PIN AND
#7008 PIN BULB BY MDS
- #7018 FASTENER BY MDS

- SEE CONTRACT DOCUMENTS
FOR EXACT CONSTRUCTION
DETAILS
- #7019 FASTENER BY MDS
- #7020 FASTENER BY MDS
- ACM PANEL BY MDS

NOTE:
AIR/MOISTURE BARRIER
INSTALLER MUST PROVIDE
WEATHER TIGHT SEAL AT
ALL BARRIER TERMINATIONS

<p>THE INFORMATION CONTAINED IN THIS DRAWING IS THE SOLE PROPERTY OF METAL DESIGN SYSTEMS. ANY REPRODUCTION, IN PART OR WHOLE, WITHOUT THE WRITTEN PERMISSION OF METAL DESIGN SYSTEMS IS PROHIBITED.</p>	 METAL DESIGN SYSTEMS <small>DESIGNED FOR A PERFECT FIT.</small>	METAL DESIGN SYSTEMS 4150 C Street S.W. CEDAR RAPIDS, IA. 52404 Ph. (319) 362-7454	PROJECT SERIES 70 DETAILS				
		DRAWING DESCRIPTION VERTICAL JOINT W/ FURRING CHANNEL			PROJECT NUMBER	DRAWING NUMBER S70-ACM-04C	DATE 6.02.14
		MATERIAL			SCALE 6" = 1'-0"		DRAWN BY

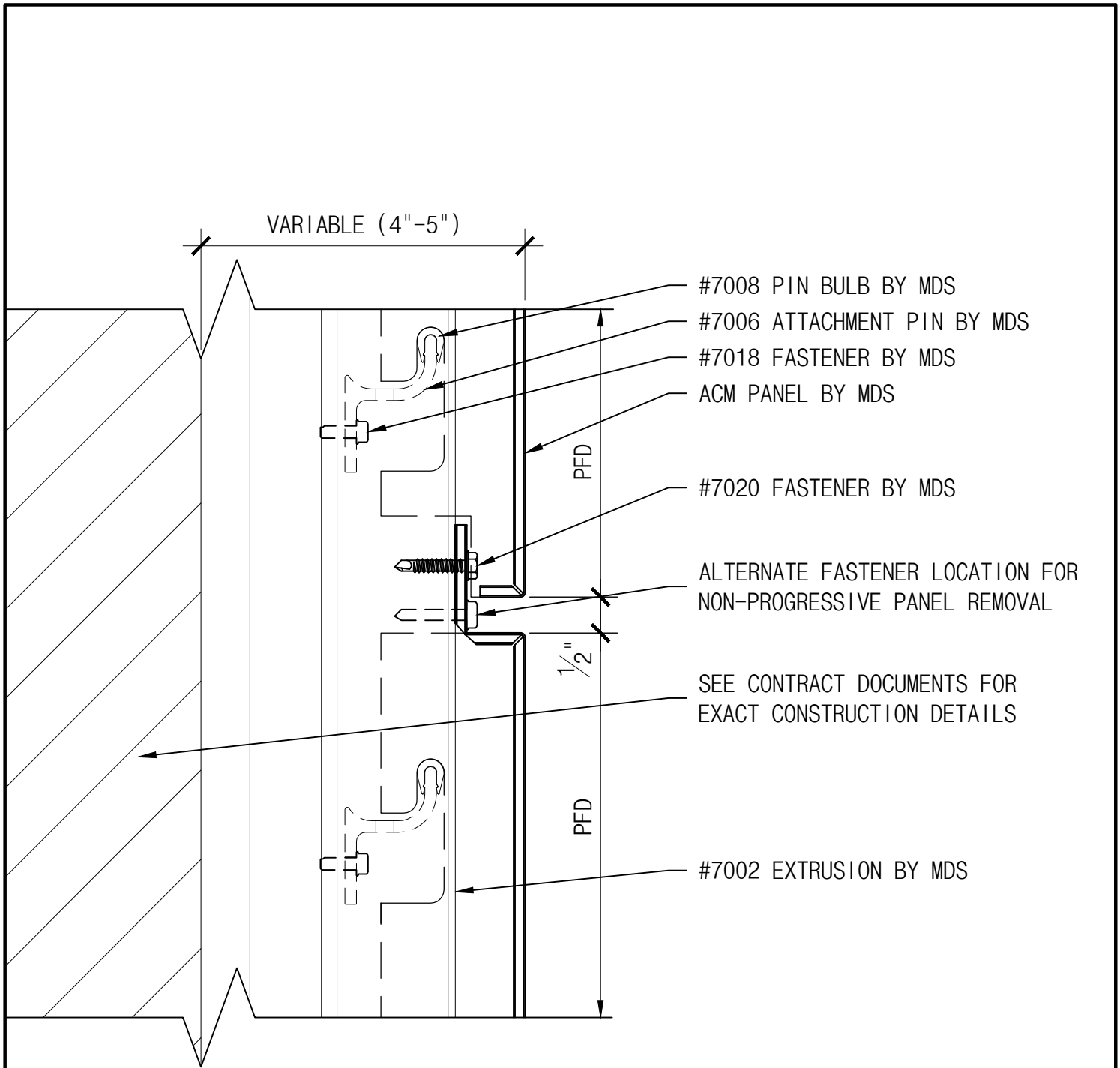

NOTE:
 AIR/MOISTURE BARRIER
 INSTALLER MUST PROVIDE
 WEATHER TIGHT SEAL AT
 ALL BARRIER TERMINATIONS

<p>THE INFORMATION CONTAINED IN THIS DRAWING IS THE SOLE PROPERTY OF METAL DESIGN SYSTEMS. ANY REPRODUCTION, IN PART OR WHOLE, WITHOUT THE WRITTEN PERMISSION OF METAL DESIGN SYSTEMS IS PROHIBITED.</p>	 METAL DESIGN SYSTEMS <small>DESIGNED FOR A PERFECT FIT.</small>	METAL DESIGN SYSTEMS		PROJECT SERIES 70 DETAILS			
		4150 C Street S.W. CEDAR RAPIDS, IA. 52404 Ph. (319) 362-7454		DRAWING DESCRIPTION HORIZONTAL JOINT DETAIL (TYP.)			
				PROJECT NUMBER	DRAWING NUMBER S70-ACM-05A	DATE 6.02.14	
		MATERIAL		SCALE 6" = 1'-0"		DRAWN BY	

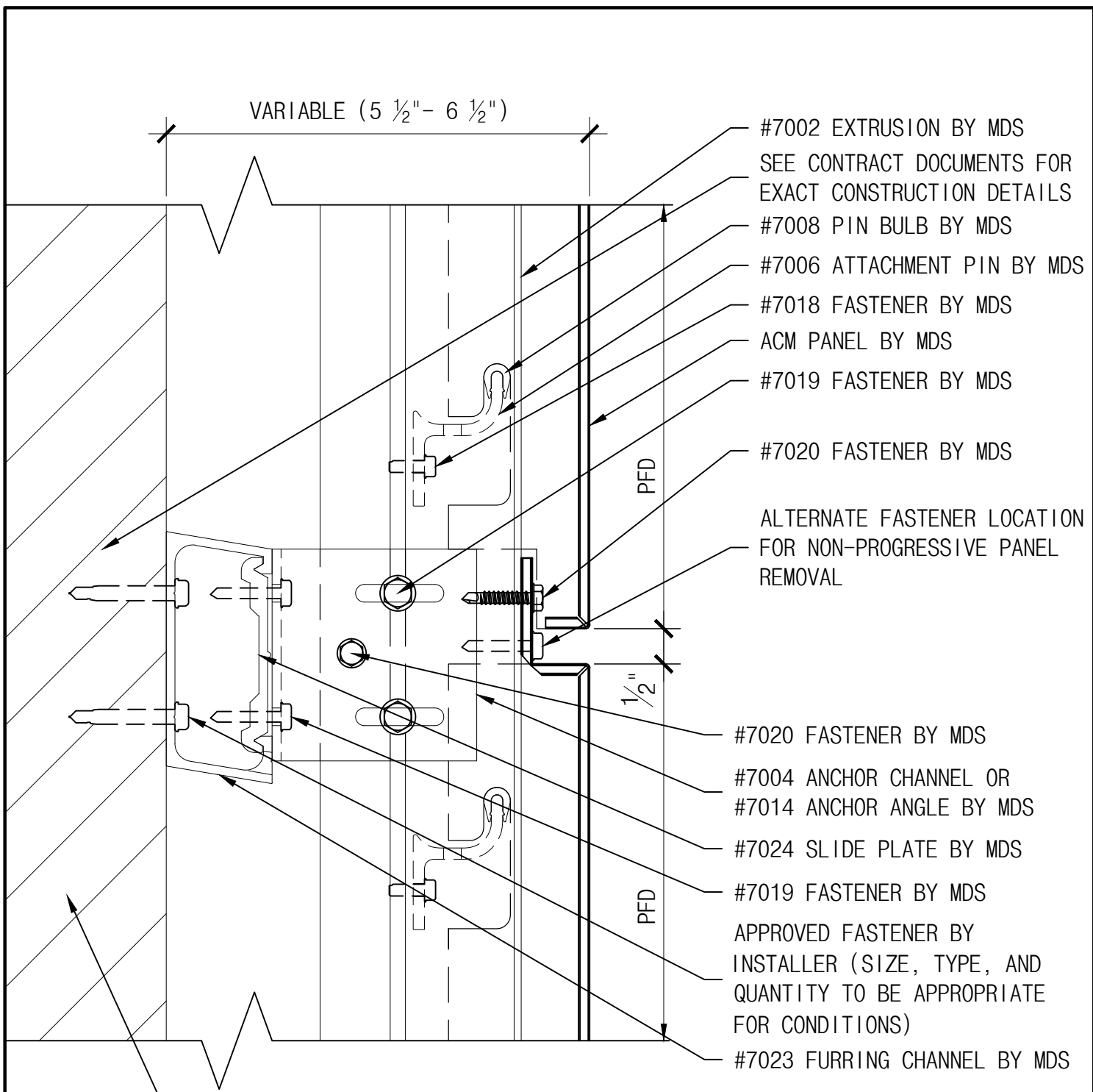

SEE CONTRACT DOCUMENTS FOR EXACT CONSTRUCTION DETAILS

NOTE:
AIR/MOISTURE BARRIER INSTALLER MUST PROVIDE WEATHER TIGHT SEAL AT ALL BARRIER TERMINATIONS

<p>THE INFORMATION CONTAINED IN THIS DRAWING IS THE SOLE PROPERTY OF METAL DESIGN SYSTEMS. ANY REPRODUCTION, IN PART OR WHOLE, WITHOUT THE WRITTEN PERMISSION OF METAL DESIGN SYSTEMS IS PROHIBITED.</p>	 METAL DESIGN SYSTEMS <small>DESIGNED FOR A PERFECT FIT.</small>	METAL DESIGN SYSTEMS		PROJECT SERIES 70 DETAILS			
		4150 C Street S.W. CEDAR RAPIDS, IA. 52404 Ph. (319) 362-7454		DRAWING DESCRIPTION HORIZONTAL JOINT - FURRING CHANNEL			
		MATERIAL		PROJECT NUMBER	DRAWING NUMBER S70-ACM-05B	DATE 6.02.14	
		SCALE 6" = 1'-0"		DRAWN BY			

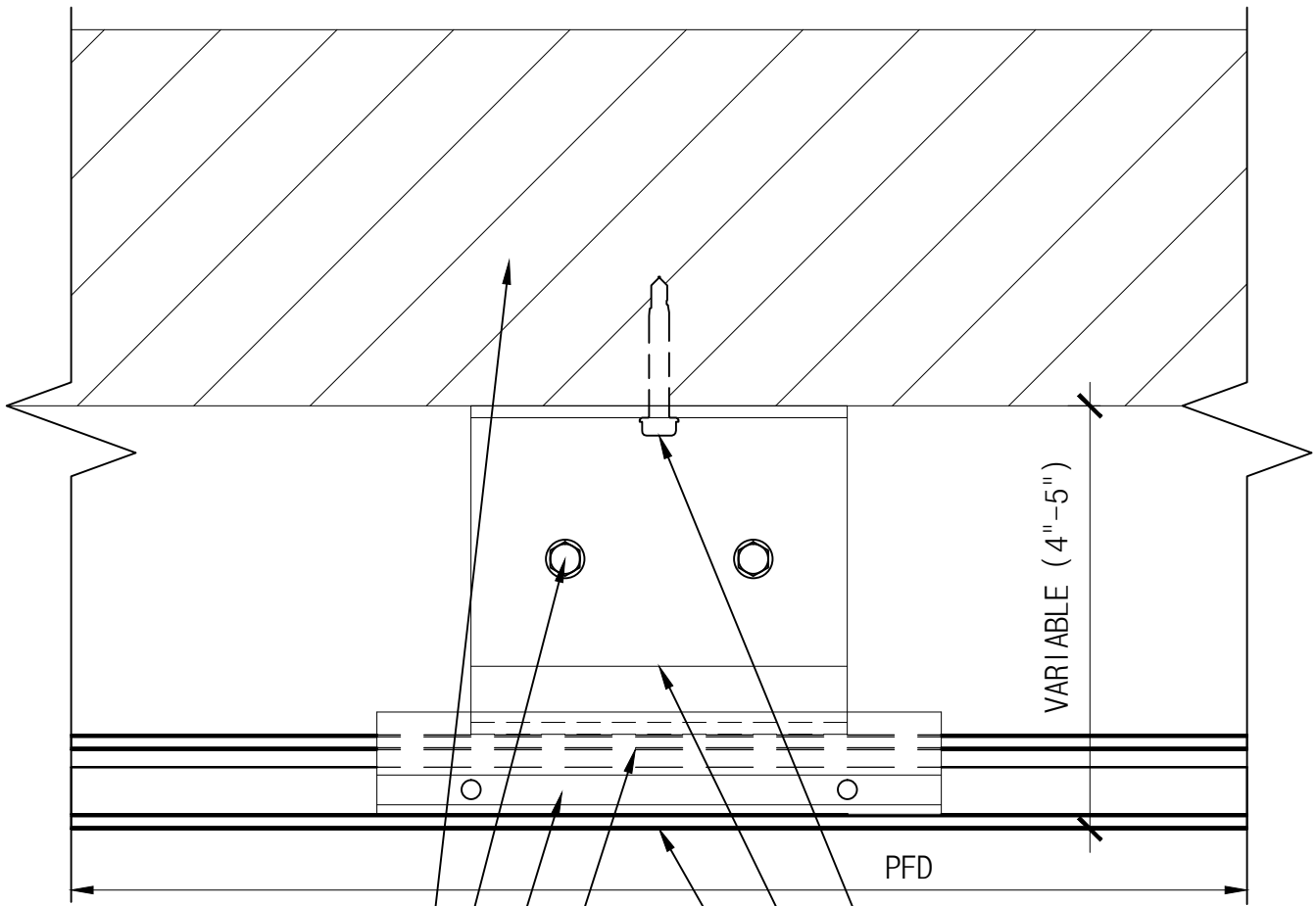

SEE CONTRACT DOCUMENTS FOR EXACT CONSTRUCTION DETAILS

#7020 FASTENER BY MDS

#7005 MID SPAN CLIP BY MDS
FACTORY INSTALLED ON BOTTOM RETURN LEG OF UPPER PANEL

FLANGE OF ACM PANEL BELOW BY MDS

APPROVED FASTENER BY INSTALLER (SIZE, TYPE, AND QUANTITY TO BE APPROPRIATE FOR CONDITIONS)

#7009 AND #7010 TIE-BACK BRACKET BY MDS

ACM PANEL ABOVE BY MDS

NOTE:
AIR/MOISTURE BARRIER INSTALLER MUST PROVIDE WEATHER TIGHT SEAL AT ALL BARRIER TERMINATIONS

<p>THE INFORMATION CONTAINED IN THIS DRAWING IS THE SOLE PROPERTY OF METAL DESIGN SYSTEMS. ANY REPRODUCTION, IN PART OR WHOLE, WITHOUT THE WRITTEN PERMISSION OF METAL DESIGN SYSTEMS IS PROHIBITED.</p>	 <p>METAL DESIGN SYSTEMS DESIGNED FOR A PERFECT FIT.</p>	<p>METAL DESIGN SYSTEMS</p>		<p>PROJECT SERIES 70 DETAILS</p>		
		<p>4150 C Street S.W. CEDAR RAPIDS, IA. 52404 Ph. (319) 362-7454</p>		<p>DRAWING DESCRIPTION INTERMEDIATE SUPPORT - VERTICAL</p>		
		<p>MATERIAL</p>		<p>PROJECT NUMBER</p>	<p>DRAWING NUMBER S70-ACM-06A</p>	<p>DATE 6.02.14</p>
		<p>SCALE 6" = 1'-0"</p>		<p>DRAWN BY</p>		

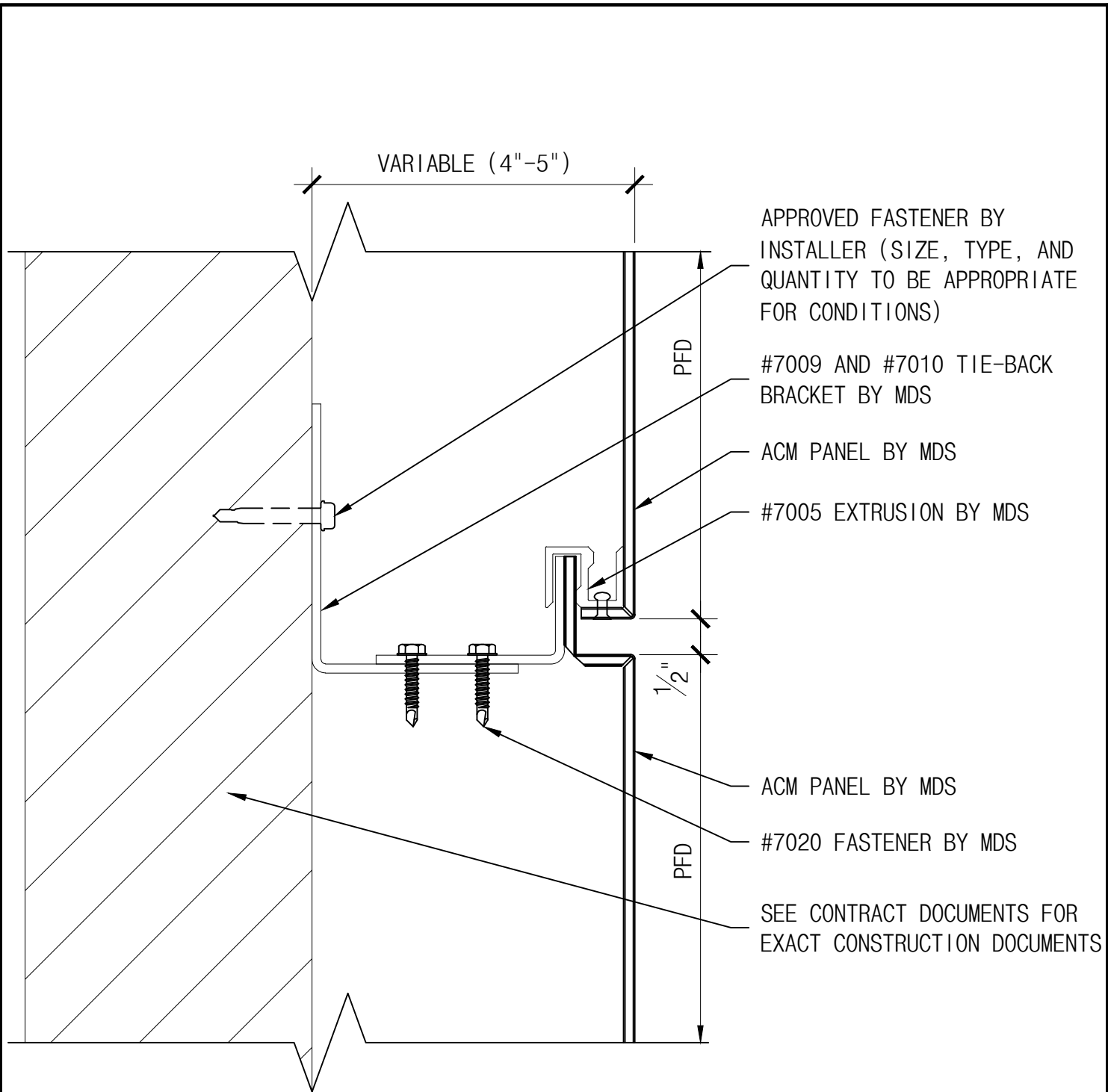

APPROVED FASTENER BY
INSTALLER (SIZE, TYPE, AND
QUANTITY TO BE APPROPRIATE
FOR CONDITIONS)

#7009 AND #7010 TIE-BACK
BRACKET BY MDS

ACM PANEL BY MDS

#7005 EXTRUSION BY MDS

ACM PANEL BY MDS

#7020 FASTENER BY MDS

SEE CONTRACT DOCUMENTS FOR
EXACT CONSTRUCTION DOCUMENTS

NOTE:
AIR/MOISTURE BARRIER
INSTALLER MUST PROVIDE
WEATHER TIGHT SEAL AT
ALL BARRIER TERMINATIONS

<p>THE INFORMATION CONTAINED IN THIS DRAWING IS THE SOLE PROPERTY OF METAL DESIGN SYSTEMS. ANY REPRODUCTION, IN PART OR WHOLE, WITHOUT THE WRITTEN PERMISSION OF METAL DESIGN SYSTEMS IS PROHIBITED.</p>	 <p>METAL DESIGN SYSTEMS DESIGNED FOR A PERFECT FIT.</p>	<p>METAL DESIGN SYSTEMS</p>		<p>PROJECT SERIES 70 DETAILS</p>		
		<p>4150 C Street S.W. CEDAR RAPIDS, IA. 52404 Ph. (319) 362-7454</p>		<p>DRAWING DESCRIPTION INTERMEDIATE SUPPORT - HORIZONTAL</p>		
		<p>MATERIAL</p>		<p>PROJECT NUMBER</p>	<p>DRAWING NUMBER S70-ACM-06B</p>	<p>DATE 6.02.14</p>
		<p>SCALE 6" = 1'-0"</p>		<p>DRAWN BY</p>		

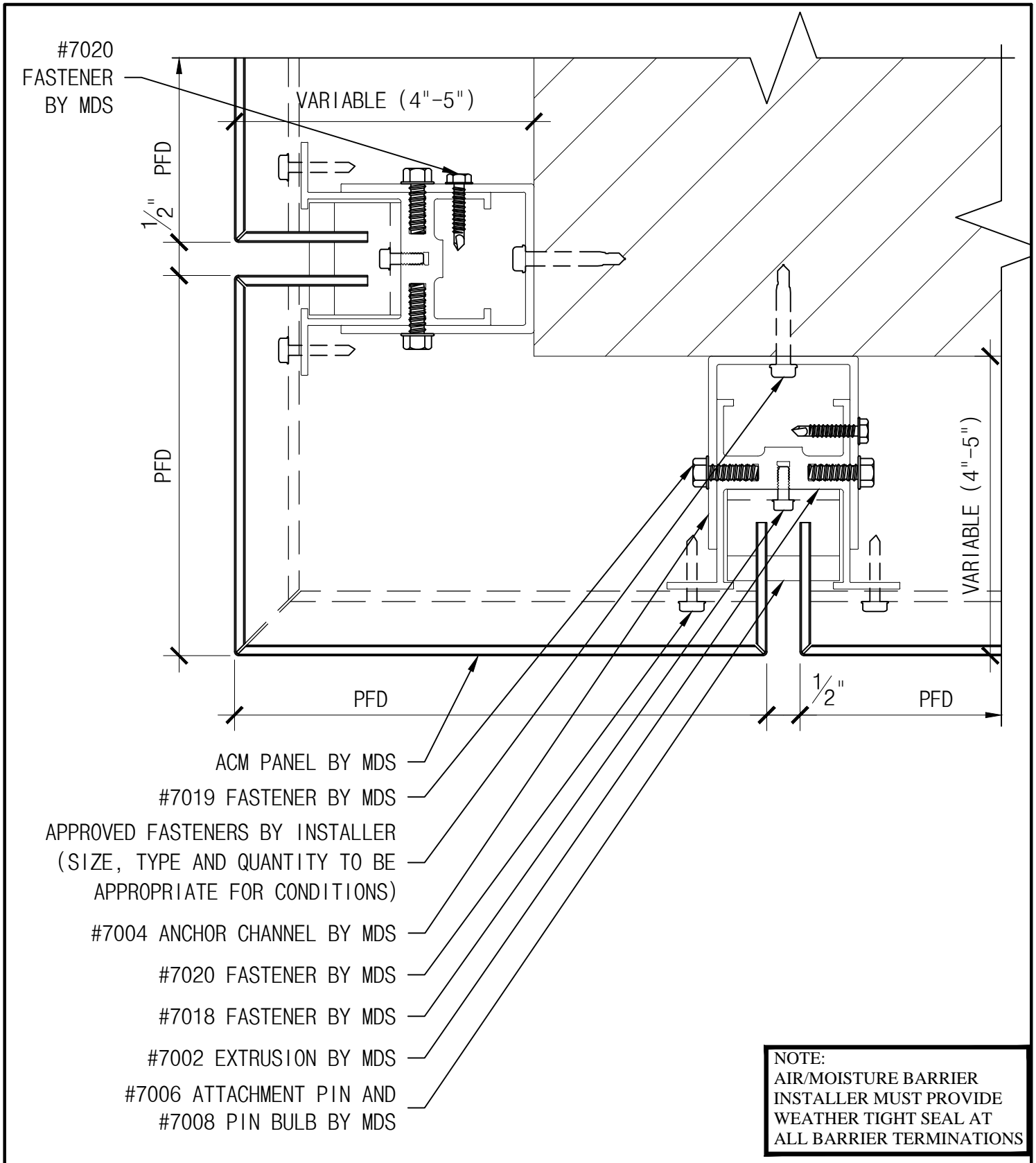

NOTE:
 AIR/MOISTURE BARRIER
 INSTALLER MUST PROVIDE
 WEATHER TIGHT SEAL AT
 ALL BARRIER TERMINATIONS

<p>THE INFORMATION CONTAINED IN THIS DRAWING IS THE SOLE PROPERTY OF METAL DESIGN SYSTEMS. ANY REPRODUCTION, IN PART OR WHOLE, WITHOUT THE WRITTEN PERMISSION OF METAL DESIGN SYSTEMS IS PROHIBITED.</p>	 METAL DESIGN SYSTEMS <small>DESIGNED FOR A PERFECT FIT.</small>	METAL DESIGN SYSTEMS		PROJECT SERIES 70 DETAILS			
		4150 C Street S.W. CEDAR RAPIDS, IA. 52404 Ph. (319) 362-7454		DRAWING DESCRIPTION OUTSIDE CORNER DETAIL (TYP.)			
		MATERIAL		PROJECT NUMBER	DRAWING NUMBER S70-ACM-07A	DATE 6.02.14	
		SCALE 6" = 1'-0"		DRAWN BY			

SEE CONTRACT DOCUMENTS FOR EXACT CONSTRUCTION DETAILS

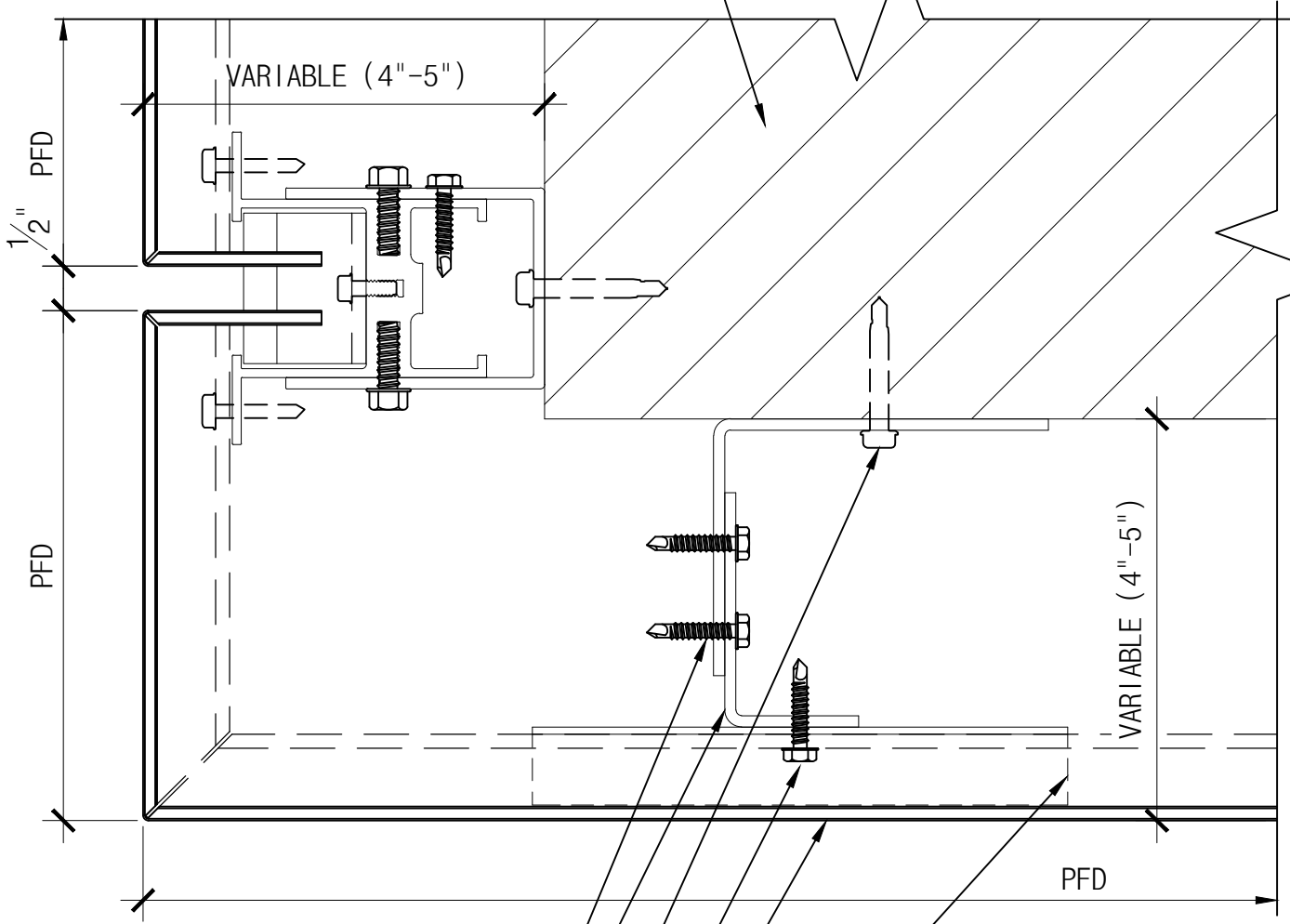

#7020 FASTENER BY MDS

#7009 AND #7010

TIE-BACK BRACKET BY MDS

APPROVED FASTENER BY
INSTALLER (TYPE, SIZE, AND QUANTITY
TO BE APPROPRIATE FOR CONDITIONS)

#7020 FASTENER BY MDS

ACM PANEL BY MDS

#7025 RETURN REINFORCEMENT ANGLE BY MDS

NOTE:
AIR/MOISTURE BARRIER
INSTALLER MUST PROVIDE
WEATHER TIGHT SEAL AT
ALL BARRIER TERMINATIONS

THE INFORMATION CONTAINED IN THIS DRAWING IS THE SOLE PROPERTY OF METAL DESIGN SYSTEMS. ANY REPRODUCTION, IN PART OR WHOLE, WITHOUT THE WRITTEN PERMISSION OF METAL DESIGN SYSTEMS IS PROHIBITED.



METAL DESIGN SYSTEMS
4150 C Street S.W.
CEDAR RAPIDS, IA. 52404
Ph. (319) 362-7454

PROJECT SERIES 70 DETAILS		
DRAWING DESCRIPTION OUTSIDE CORNER DETAIL (ALTERNATE)		
PROJECT NUMBER	DRAWING NUMBER S70-ACM-07B	DATE 6.02.14
MATERIAL	SCALE 6" = 1'-0"	DRAWN BY

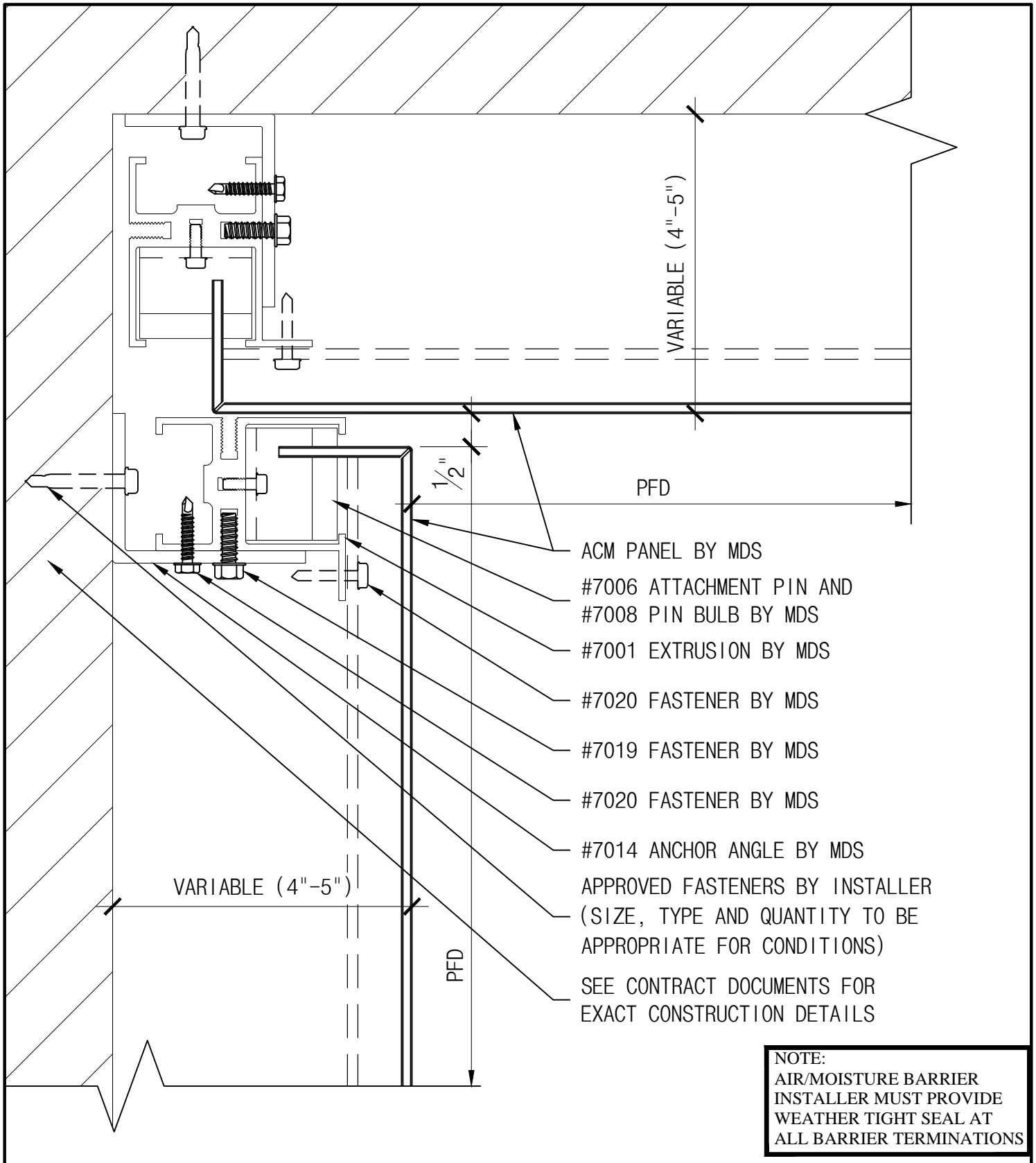

- ACM PANEL BY MDS
- #7006 ATTACHMENT PIN AND #7008 PIN BULB BY MDS
- #7001 EXTRUSION BY MDS
- #7020 FASTENER BY MDS
- #7019 FASTENER BY MDS
- #7020 FASTENER BY MDS
- #7014 ANCHOR ANGLE BY MDS
- APPROVED FASTENERS BY INSTALLER (SIZE, TYPE AND QUANTITY TO BE APPROPRIATE FOR CONDITIONS)
- SEE CONTRACT DOCUMENTS FOR EXACT CONSTRUCTION DETAILS

NOTE:
 AIR/MOISTURE BARRIER
 INSTALLER MUST PROVIDE
 WEATHER TIGHT SEAL AT
 ALL BARRIER TERMINATIONS

<p>THE INFORMATION CONTAINED IN THIS DRAWING IS THE SOLE PROPERTY OF METAL DESIGN SYSTEMS. ANY REPRODUCTION, IN PART OR WHOLE, WITHOUT THE WRITTEN PERMISSION OF METAL DESIGN SYSTEMS IS PROHIBITED.</p>	 METAL DESIGN SYSTEMS <small>DESIGNED FOR A PERFECT FIT.</small>	METAL DESIGN SYSTEMS	PROJECT		
		4150 C Street S.W. CEDAR RAPIDS, IA. 52404 Ph. (319) 362-7454	SERIES 70 DETAILS		
			DRAWING DESCRIPTION		
			INSIDE CORNER DETAIL (TYP.)		
		PROJECT NUMBER	DRAWING NUMBER	DATE	
			S70-ACM-08A	6.02.14	
	MATERIAL	SCALE	DRAWN BY		
		6" = 1'-0"			

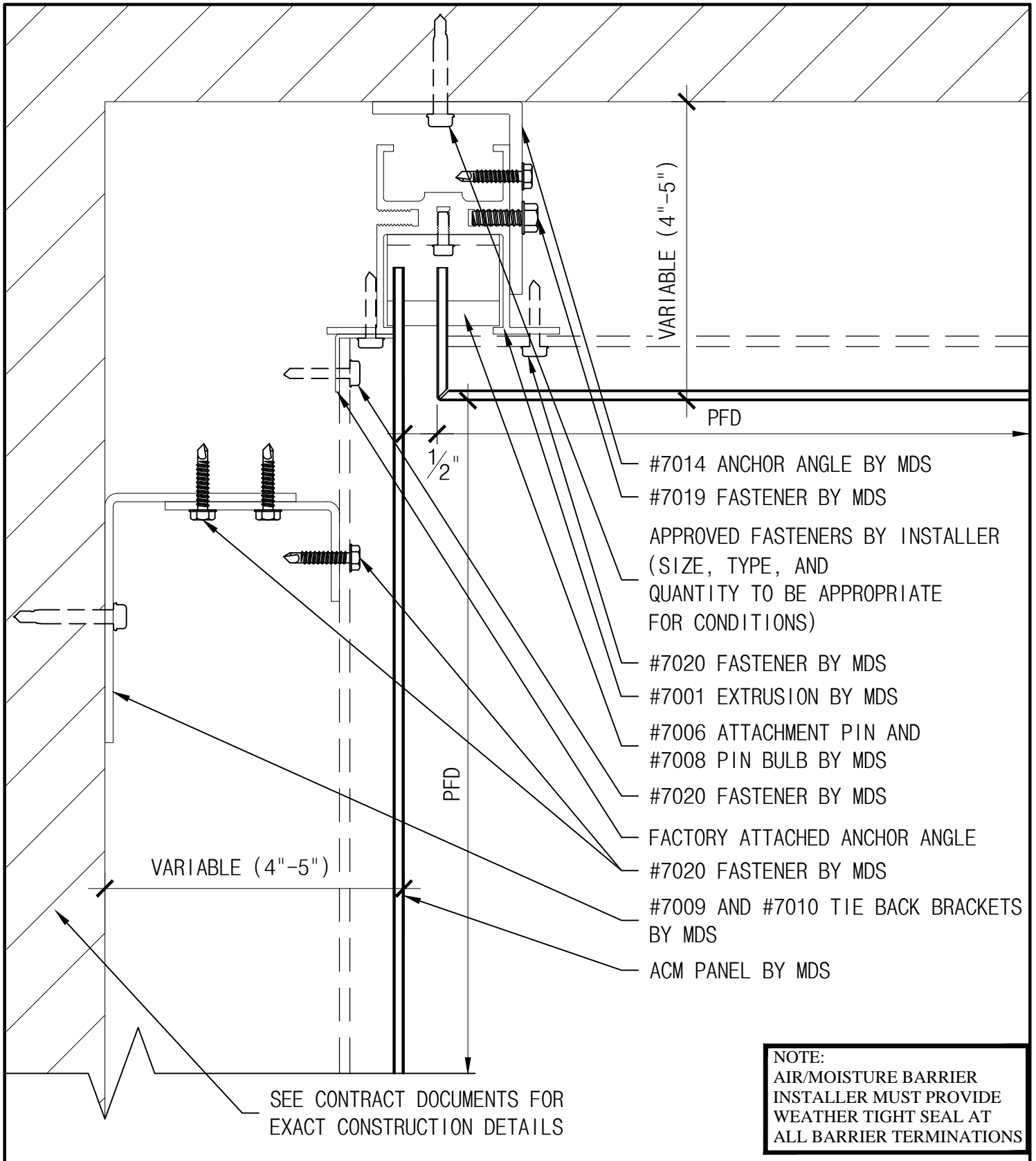

<p>THE INFORMATION CONTAINED IN THIS DRAWING IS THE SOLE PROPERTY OF METAL DESIGN SYSTEMS. ANY REPRODUCTION, IN PART OR WHOLE, WITHOUT THE WRITTEN PERMISSION OF METAL DESIGN SYSTEMS IS PROHIBITED.</p>	 <p>METAL DESIGN SYSTEMS DESIGNED FOR A PERFECT FIT.</p>	<p>METAL DESIGN SYSTEMS 4150 C Street S.W. CEDAR RAPIDS, IA. 52404 Ph. (319) 362-7454</p>	<p>PROJECT SERIES 70 DETAILS</p>				
			<p>DRAWING DESCRIPTION INSIDE CORNER DETAIL (ALTERNATE)</p>				
			<p>PROJECT NUMBER</p>	<p>DRAWING NUMBER S70-ACM-08B</p>	<p>DATE 6.02.14</p>		
			<p>MATERIAL</p>	<p>SCALE 6" = 1'-0"</p>	<p>DRAWN BY</p>		

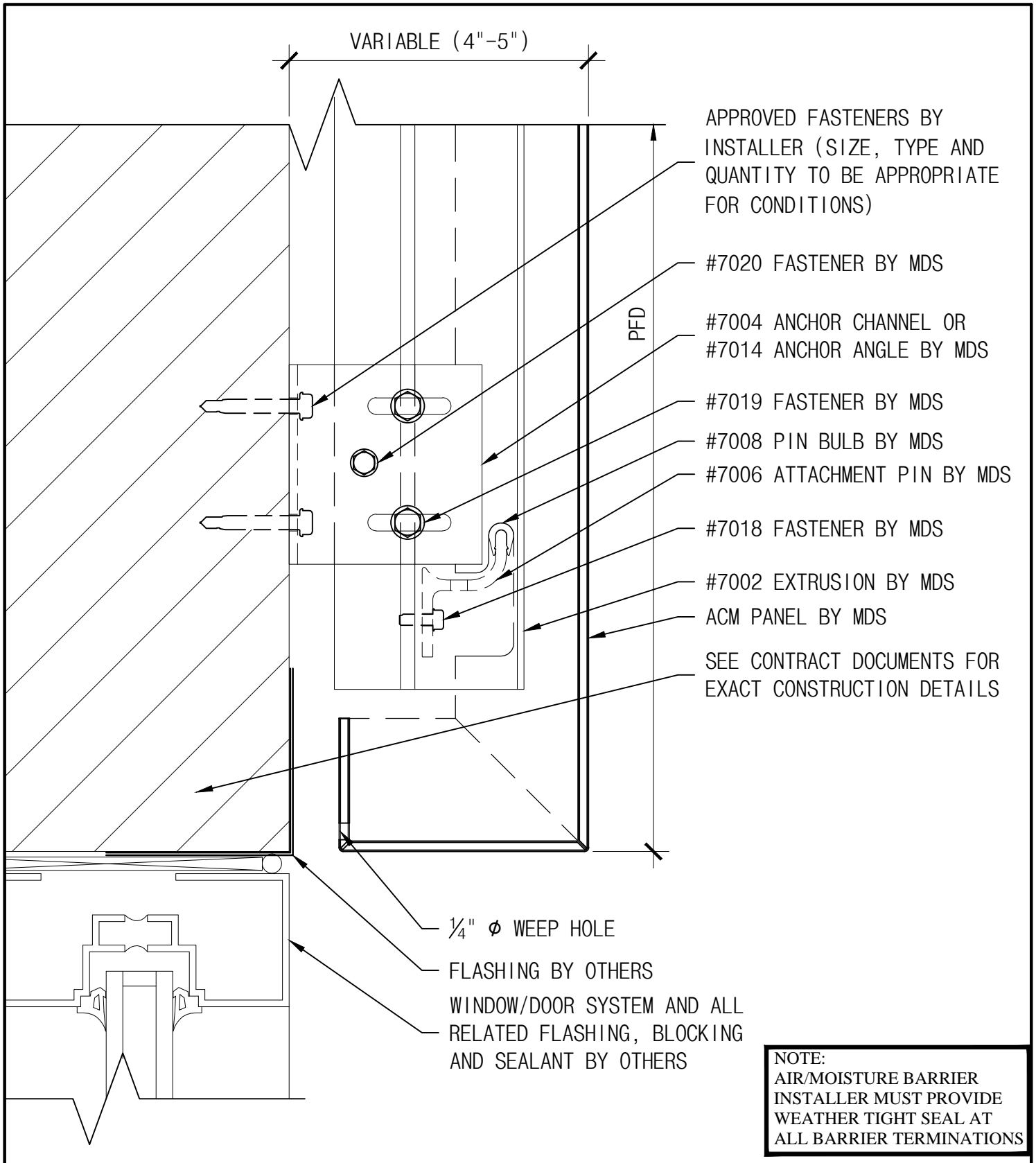

APPROVED FASTENERS BY
INSTALLER (SIZE, TYPE AND
QUANTITY TO BE APPROPRIATE
FOR CONDITIONS)

#7020 FASTENER BY MDS

#7004 ANCHOR CHANNEL OR
#7014 ANCHOR ANGLE BY MDS

#7019 FASTENER BY MDS

#7008 PIN BULB BY MDS

#7006 ATTACHMENT PIN BY MDS

#7018 FASTENER BY MDS

#7002 EXTRUSION BY MDS

ACM PANEL BY MDS

SEE CONTRACT DOCUMENTS FOR
EXACT CONSTRUCTION DETAILS

1/4" ϕ WEEP HOLE

FLASHING BY OTHERS

WINDOW/DOOR SYSTEM AND ALL
RELATED FLASHING, BLOCKING
AND SEALANT BY OTHERS

NOTE:
AIR/MOISTURE BARRIER
INSTALLER MUST PROVIDE
WEATHER TIGHT SEAL AT
ALL BARRIER TERMINATIONS

<p>THE INFORMATION CONTAINED IN THIS DRAWING IS THE SOLE PROPERTY OF METAL DESIGN SYSTEMS. ANY REPRODUCTION, IN PART OR WHOLE, WITHOUT THE WRITTEN PERMISSION OF METAL DESIGN SYSTEMS IS PROHIBITED.</p>	 <p>METAL DESIGN SYSTEMS DESIGNED FOR A PERFECT FIT.</p>	<p>METAL DESIGN SYSTEMS</p>		<p>PROJECT SERIES 70 DETAILS</p>		
		<p>4150 C Street S.W. CEDAR RAPIDS, IA. 52404 Ph. (319) 362-7454</p>		<p>DRAWING DESCRIPTION WINDOW/DOOR HEAD DETAIL (TYP.)</p>		
		<p>MATERIAL</p>		<p>PROJECT NUMBER</p>	<p>DRAWING NUMBER S70-ACM-09</p>	<p>DATE 6.02.14</p>
		<p>SCALE 6" = 1'-0"</p>		<p>DRAWN BY</p>		

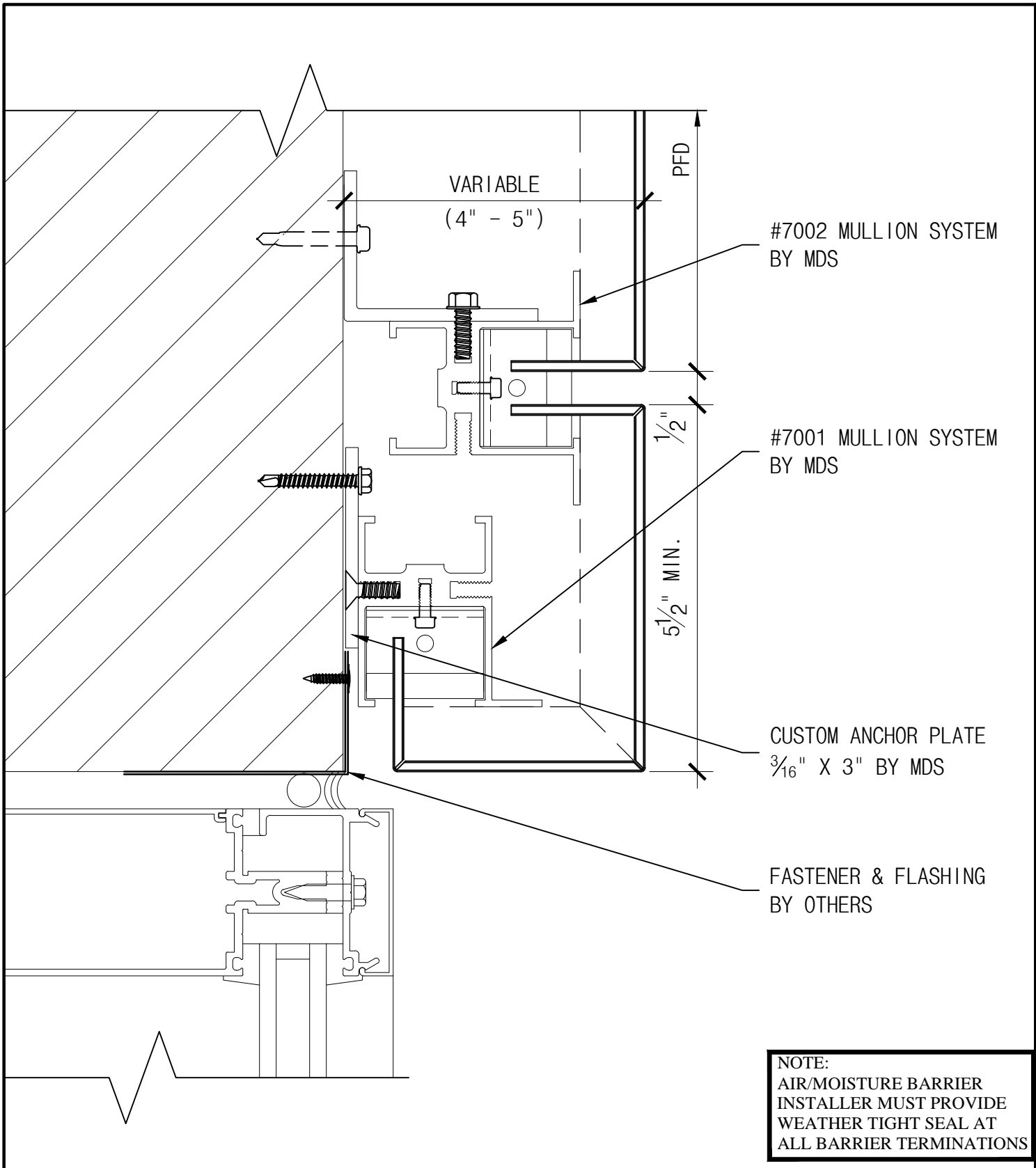

<p>THE INFORMATION CONTAINED IN THIS DRAWING IS THE SOLE PROPERTY OF METAL DESIGN SYSTEMS. ANY REPRODUCTION, IN PART OR WHOLE, WITHOUT THE WRITTEN PERMISSION OF METAL DESIGN SYSTEMS IS PROHIBITED.</p>	 METAL DESIGN SYSTEMS <small>DESIGNED FOR A PERFECT FIT.</small>	METAL DESIGN SYSTEMS		PROJECT SERIES 70 DETAILS			
		4150 C Street S.W. CEDAR RAPIDS, IA. 52404 Ph. (319) 362-7454		DRAWING DESCRIPTION WINDOW/DOOR JAMB DETAIL (TYP.)			
		MATERIAL		PROJECT NUMBER	DRAWING NUMBER S70-ACM-10	DATE 6.02.14	
		SCALE 6" = 1'-0"		DRAWN BY			

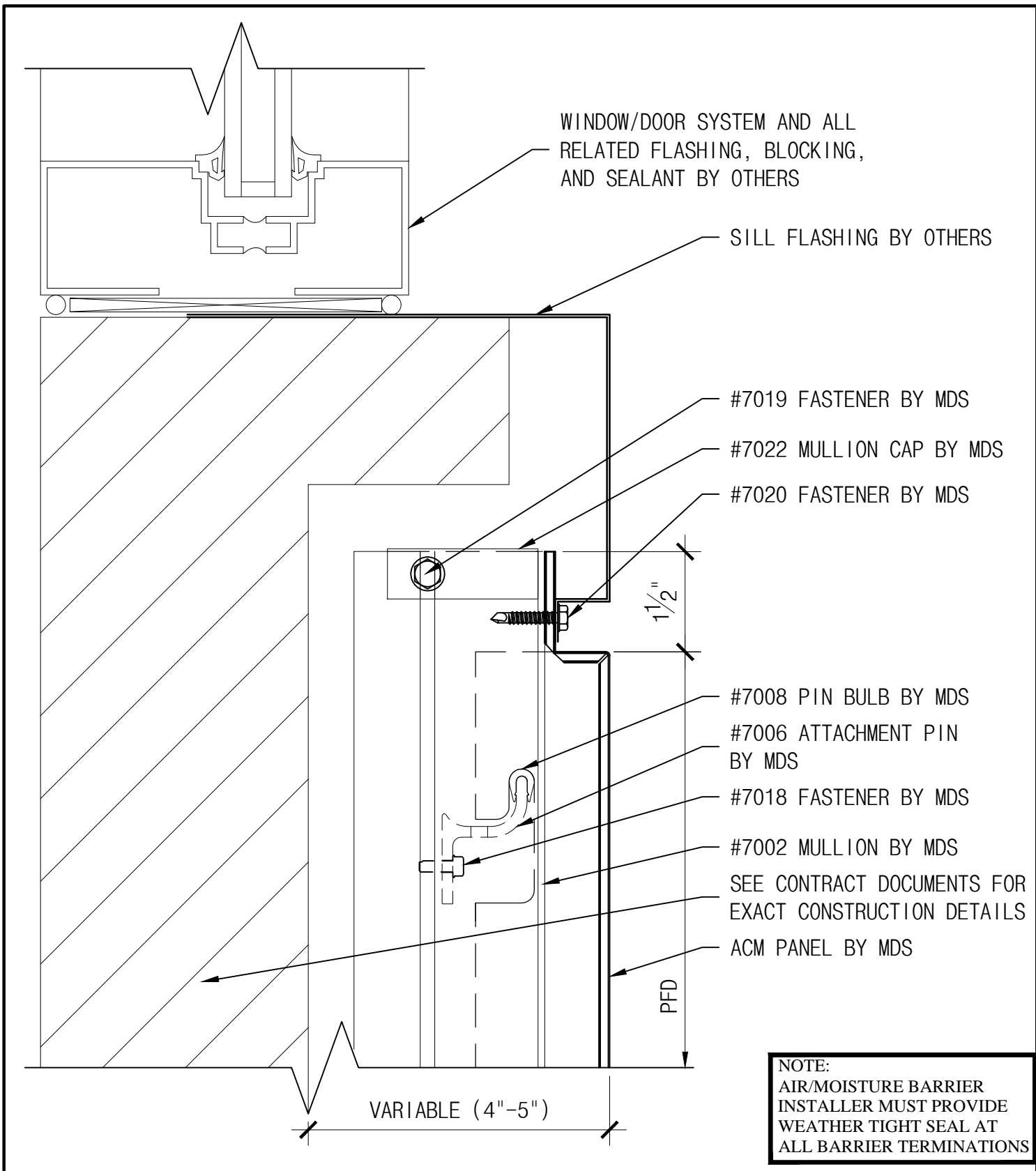

<p>THE INFORMATION CONTAINED IN THIS DRAWING IS THE SOLE PROPERTY OF METAL DESIGN SYSTEMS. ANY REPRODUCTION, IN PART OR WHOLE, WITHOUT THE WRITTEN PERMISSION OF METAL DESIGN SYSTEMS IS PROHIBITED.</p>	 <p>METAL DESIGN SYSTEMS DESIGNED FOR A PERFECT FIT.</p>	<p>METAL DESIGN SYSTEMS</p>		<p>PROJECT SERIES 70 DETAILS</p>		
		<p>4150 C Street S.W. CEDAR RAPIDS, IA. 52404 Ph. (319) 362-7454</p>		<p>DRAWING DESCRIPTION WINDOW SILL DETAIL (TYP.)</p>		
		<p>MATERIAL</p>		<p>PROJECT NUMBER</p>	<p>DRAWING NUMBER S70-ACM-11A</p>	<p>DATE 6.02.14</p>
		<p>6" = 1'-0"</p>		<p>SCALE</p>		<p>DRAWN BY</p>

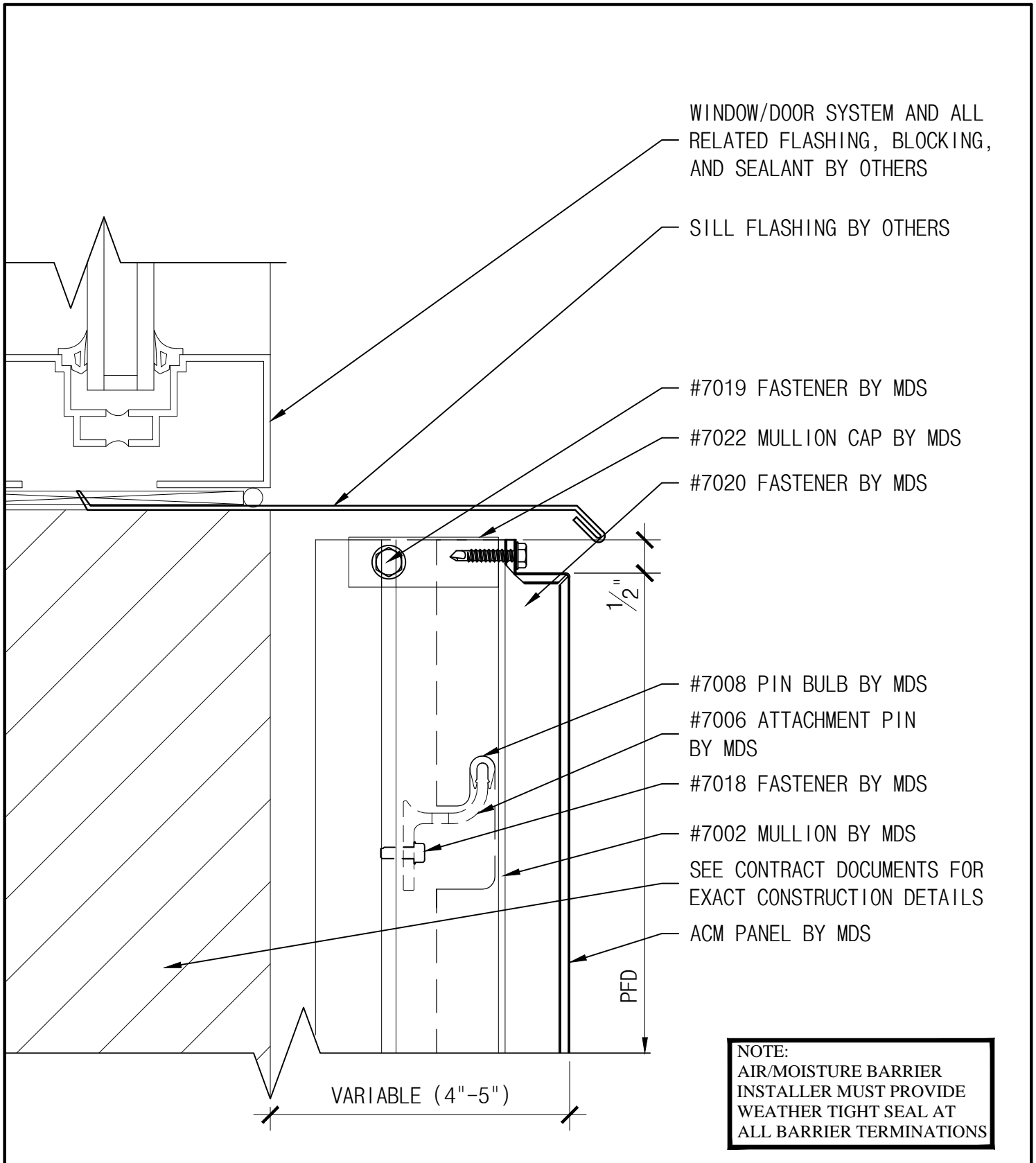

NOTE:
 AIR/MOISTURE BARRIER
 INSTALLER MUST PROVIDE
 WEATHER TIGHT SEAL AT
 ALL BARRIER TERMINATIONS

<p>THE INFORMATION CONTAINED IN THIS DRAWING IS THE SOLE PROPERTY OF METAL DESIGN SYSTEMS. ANY REPRODUCTION, IN PART OR WHOLE, WITHOUT THE WRITTEN PERMISSION OF METAL DESIGN SYSTEMS IS PROHIBITED.</p>	 METAL DESIGN SYSTEMS <small>DESIGNED FOR A PERFECT FIT.</small>	METAL DESIGN SYSTEMS	PROJECT		
		4150 C Street S.W. CEDAR RAPIDS, IA. 52404 Ph. (319) 362-7454	SERIES 70 DETAILS		
			DRAWING DESCRIPTION		
			WINDOW SILL DETAIL (ALT.)		
		PROJECT NUMBER	DRAWING NUMBER	DATE	
			S70-ACM-11B	6.02.14	
	MATERIAL	SCALE	DRAWN BY		
		6" = 1'-0"			

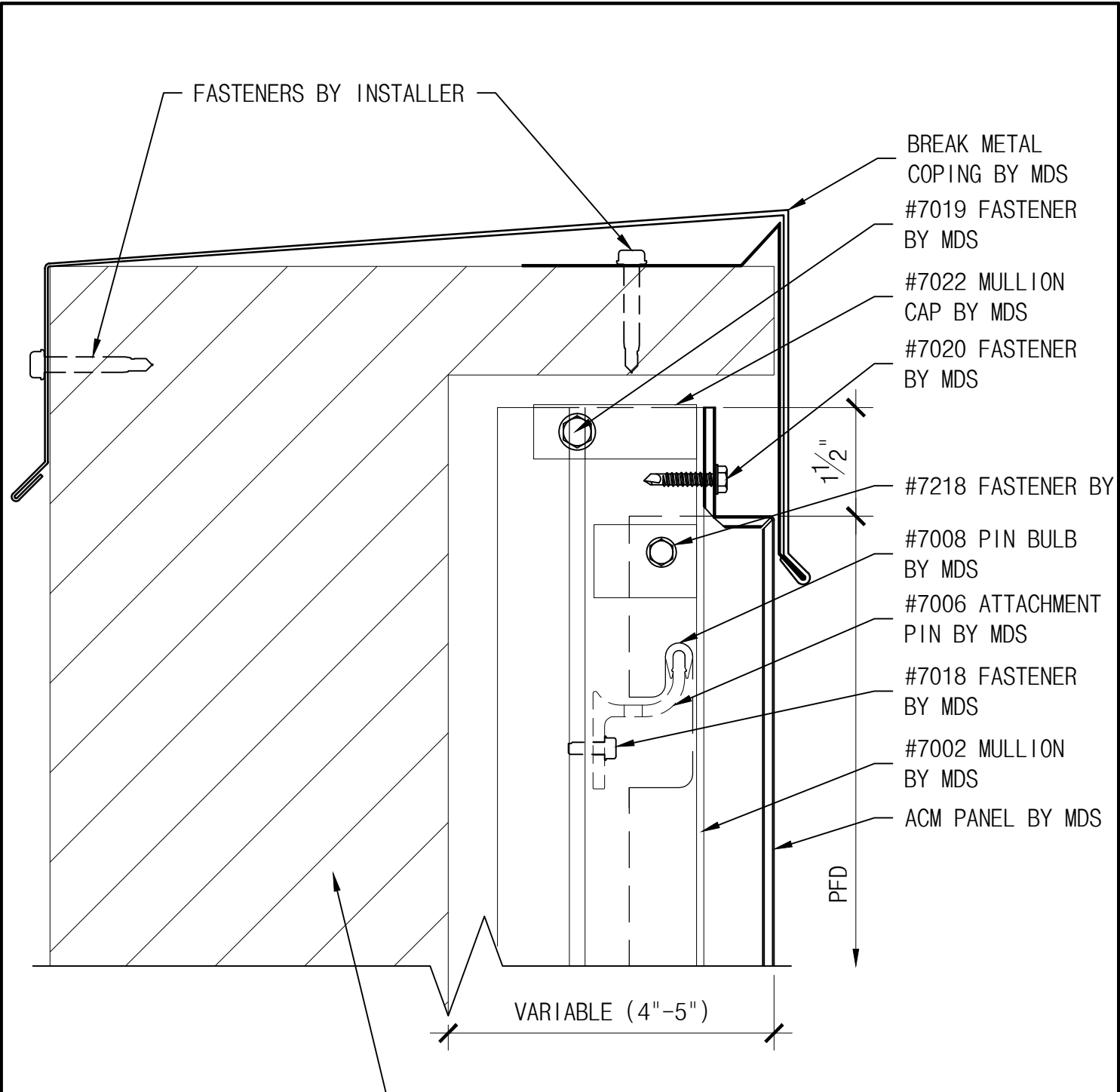

NOTE:
 AIR/MOISTURE BARRIER
 INSTALLER MUST PROVIDE
 WEATHER TIGHT SEAL AT
 ALL BARRIER TERMINATIONS

<p>THE INFORMATION CONTAINED IN THIS DRAWING IS THE SOLE PROPERTY OF METAL DESIGN SYSTEMS. ANY REPRODUCTION, IN PART OR WHOLE, WITHOUT THE WRITTEN PERMISSION OF METAL DESIGN SYSTEMS IS PROHIBITED.</p>	 <p>METAL DESIGN SYSTEMS <small>DESIGNED FOR A PERFECT FIT.</small></p>	<p>METAL DESIGN SYSTEMS</p>		<p>PROJECT SERIES 70 DETAILS</p>			
		<p>4150 C Street S.W. CEDAR RAPIDS, IA. 52404 Ph. (319) 362-7454</p>		<p>DRAWING DESCRIPTION COPING DETAIL (TYP.)</p>			
		<p>MATERIAL</p>		<p>PROJECT NUMBER</p>	<p>DRAWING NUMBER S70-ACM-12</p>	<p>DATE 6.02.14</p>	
		<p>6" = 1'-0"</p>		<p>SCALE</p>		<p>DRAWN BY</p>	

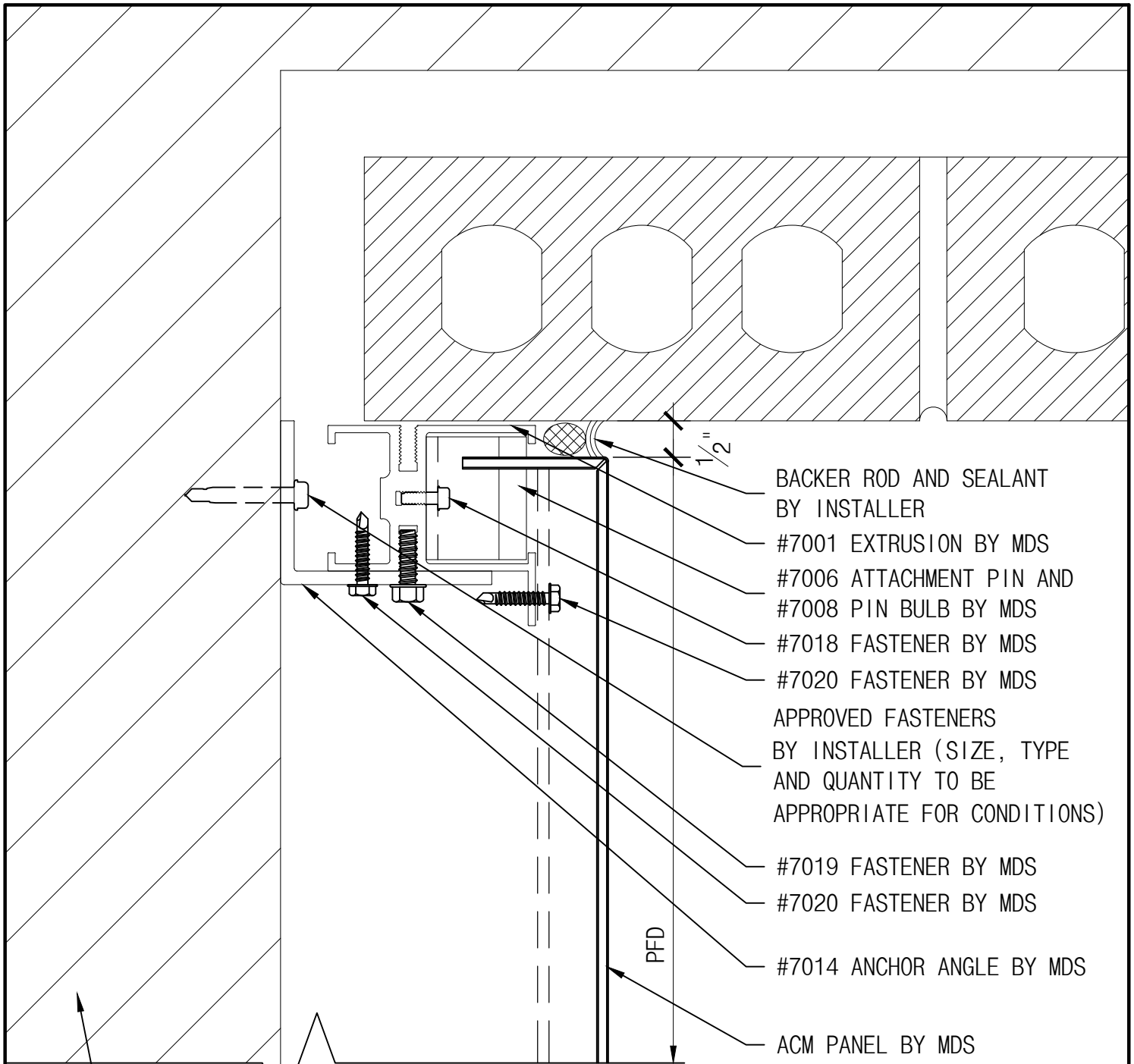

- BACKER ROD AND SEALANT BY INSTALLER
- #7001 EXTRUSION BY MDS
- #7006 ATTACHMENT PIN AND #7008 PIN BULB BY MDS
- #7018 FASTENER BY MDS
- #7020 FASTENER BY MDS
- APPROVED FASTENERS BY INSTALLER (SIZE, TYPE AND QUANTITY TO BE APPROPRIATE FOR CONDITIONS)
- #7019 FASTENER BY MDS
- #7020 FASTENER BY MDS
- #7014 ANCHOR ANGLE BY MDS
- ACM PANEL BY MDS

VARIABLE (4"-5")

SEE CONTRACT DOCUMENTS FOR EXACT CONSTRUCTION DETAILS

NOTE:
AIR/MOISTURE BARRIER INSTALLER MUST PROVIDE WEATHER TIGHT SEAL AT ALL BARRIER TERMINATIONS

<p>THE INFORMATION CONTAINED IN THIS DRAWING IS THE SOLE PROPERTY OF METAL DESIGN SYSTEMS. ANY REPRODUCTION, IN PART OR WHOLE, WITHOUT THE WRITTEN PERMISSION OF METAL DESIGN SYSTEMS IS PROHIBITED.</p>	 METAL DESIGN SYSTEMS <small>DESIGNED FOR A PERFECT FIT.</small>	METAL DESIGN SYSTEMS		PROJECT SERIES 70 DETAILS			
		4150 C Street S.W. CEDAR RAPIDS, IA. 52404 Ph. (319) 362-7454		DRAWING DESCRIPTION PANEL TERMINATION @ MASONRY (TYP.)			
		MATERIAL		PROJECT NUMBER	DRAWING NUMBER S70-ACM-13	DATE 6.02.14	
		SCALE 6" = 1'-0"		DRAWN BY			

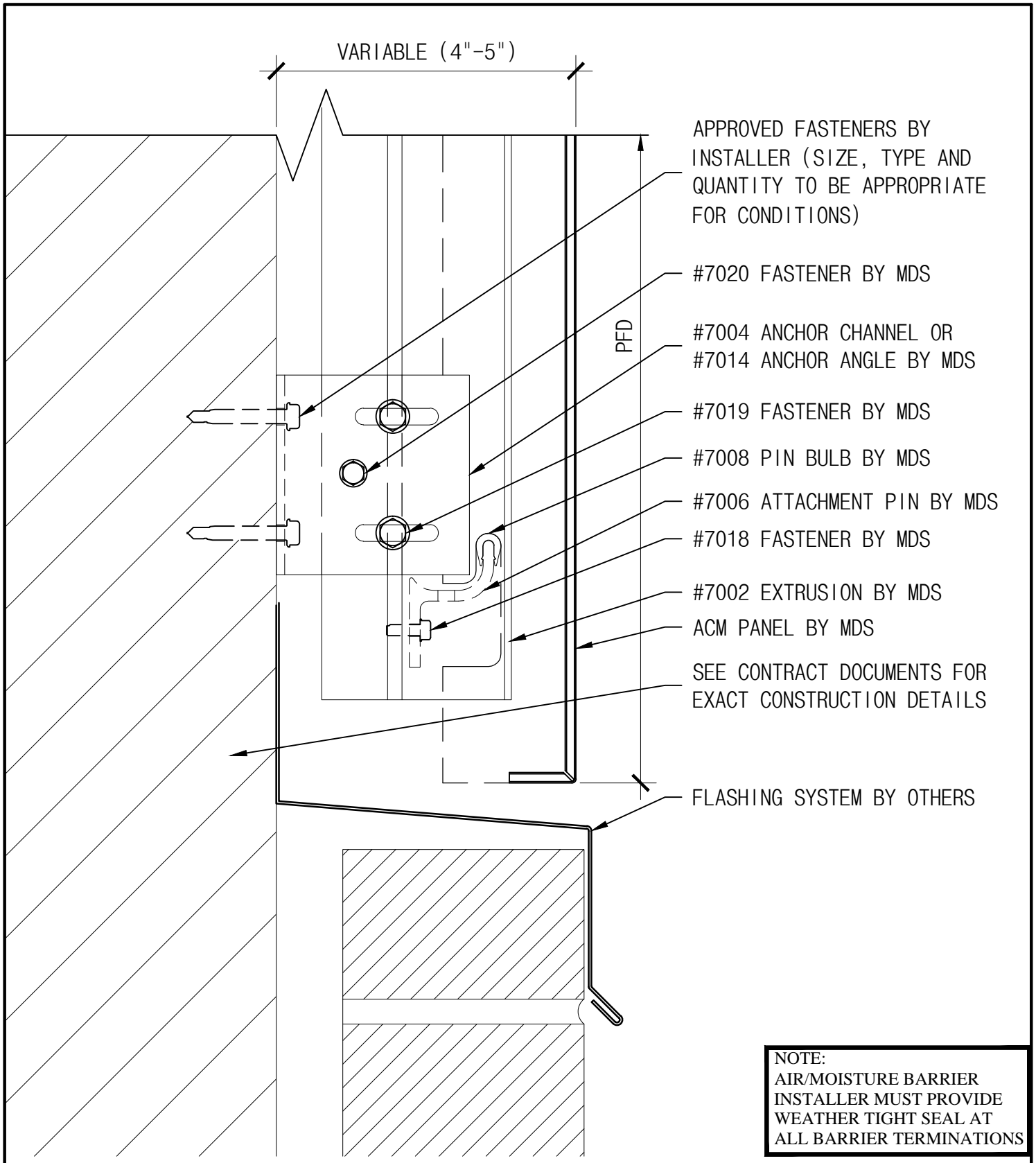

APPROVED FASTENERS BY
INSTALLER (SIZE, TYPE AND
QUANTITY TO BE APPROPRIATE
FOR CONDITIONS)

#7020 FASTENER BY MDS

#7004 ANCHOR CHANNEL OR
#7014 ANCHOR ANGLE BY MDS

#7019 FASTENER BY MDS

#7008 PIN BULB BY MDS

#7006 ATTACHMENT PIN BY MDS

#7018 FASTENER BY MDS

#7002 EXTRUSION BY MDS

ACM PANEL BY MDS

SEE CONTRACT DOCUMENTS FOR
EXACT CONSTRUCTION DETAILS

FLASHING SYSTEM BY OTHERS

NOTE:
AIR/MOISTURE BARRIER
INSTALLER MUST PROVIDE
WEATHER TIGHT SEAL AT
ALL BARRIER TERMINATIONS

<p>THE INFORMATION CONTAINED IN THIS DRAWING IS THE SOLE PROPERTY OF METAL DESIGN SYSTEMS. ANY REPRODUCTION, IN PART OR WHOLE, WITHOUT THE WRITTEN PERMISSION OF METAL DESIGN SYSTEMS IS PROHIBITED.</p>	 <p>METAL DESIGN SYSTEMS DESIGNED FOR A PERFECT FIT.</p>	<p>METAL DESIGN SYSTEMS</p>		<p>PROJECT SERIES 70 DETAILS</p>			
		<p>4150 C Street S.W. CEDAR RAPIDS, IA. 52404 Ph. (319) 362-7454</p>		<p>DRAWING DESCRIPTION MASONRY SILL DETAIL (TYP.)</p>			
		<p>MATERIAL</p>		<p>PROJECT NUMBER</p>	<p>DRAWING NUMBER S70-ACM-14</p>	<p>DATE 6.02.14</p>	
		<p>SCALE 6" = 1'-0"</p>		<p>DRAWN BY</p>			